



Diagnostic and Imaging Equipment



Treatment Units



Handpieces and Instruments



Endodontic Systems



Laser Equipment



Laboratory Devices



Sharp down to the last detail.
For reliable diagnoses.

Veraview X800



Distribution
J. Morita Europe GmbH
Justus-von-Liebig-Str. 27a
63128 Dietzenbach
Germany
T +49. 6074. 836 0, F +49. 6074. 836 299
www.morita.com/europe

Development and Manufacturing
J. MORITA MFG. CORP.
680 Higashihama Minami-cho, Fushimi-ku
Kyoto 612-8533
Japan
T +81. 75. 611 2141, F +81. 75. 622 4595
www.morita.com

Subject to technical changes and errors.
JME EN PUB 002487 0317 *1,5.

Thinking ahead. Focused on life.

A sharp-eyed view: Absolutely sharp images and maximum patient health

The Veraview X800 dental X-ray system brings every detail to light, in absolutely sharp resolution. With its maximum resolution (voxel size of 80 µm) and innovative functions, this ultra-class system provides the perfect foundation for a thoroughly reliable diagnosis. And it consistently keeps your patients' health in mind in other ways, too. Because there's no reason you can't combine optimum image quality with a low radiation dose. As is proven in several ways by the combined panoramic, cephalometric, and 3D imaging system – for example, with eleven different fields of view that always ensure the lowest dose while providing the best image quality.



Outstanding performance: The Veraview X800 itself is picture-perfect – as the jury for the IF Design Awards agreed. They awarded it a gold medal for its exterior style.

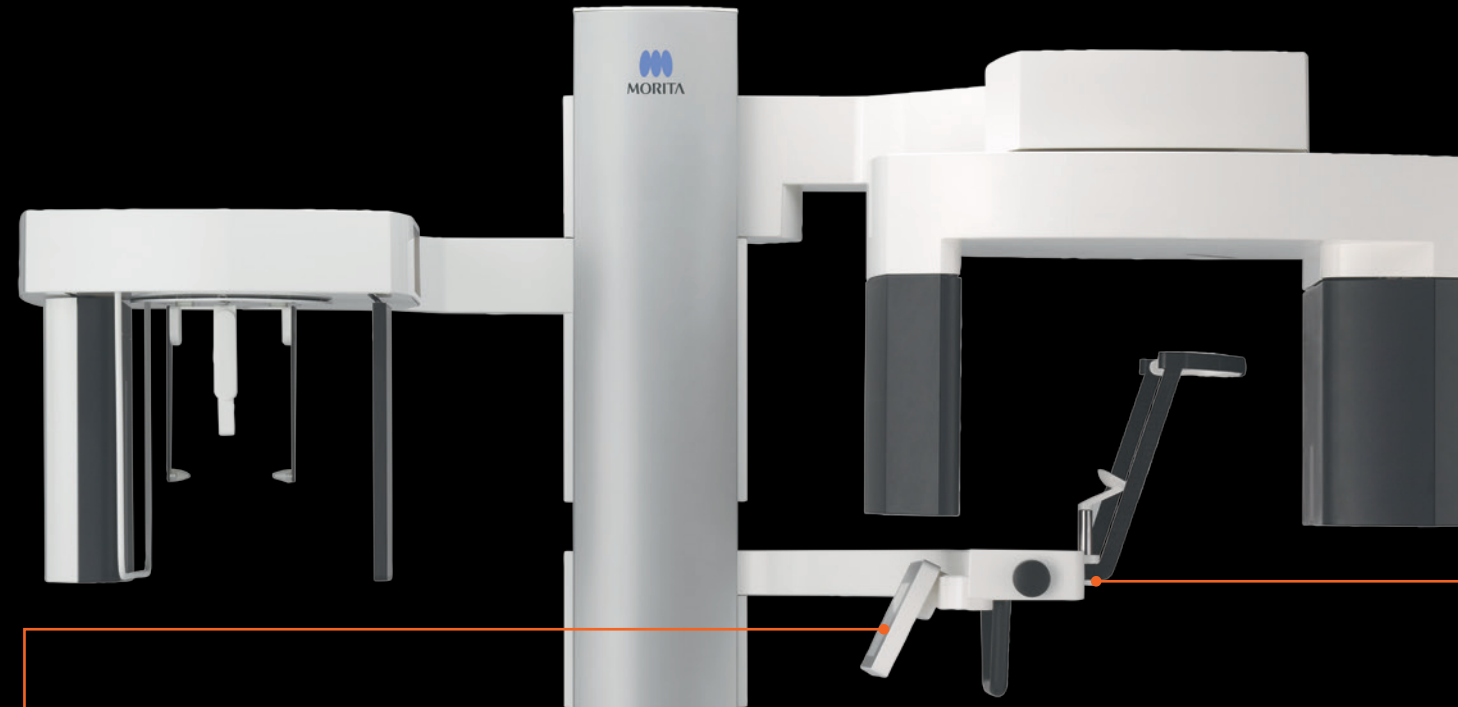

Face-to-face positioning:

Face-to-face positioning ensures better communication with your patient as you focus the laser beam localizer for the laser. At the same time, the flexible control panel assists with precise patient positioning, because you can input all settings via easily understandable pictograms, without taking your eyes off your patient.

Three different models:

The Veraview X800 comes in three models – S, M and L – with or without the cephalometric function. A variety of stand configurations are also available.



Comfortable for patients:

The chin rest, which can be lowered to 1,005 mm, means that even small patients or patients with limited movement can be positioned easily and comfortably.

Unique image quality:

The Veraview X800's impressive 3D images also let you modify X-ray images afterwards. The system offers a number of new panoramic functions as well, including Adaptive Focal Point (AFP) and Adaptive Gray Scale (AGS). The best possible conditions for an all-around perfect diagnosis.

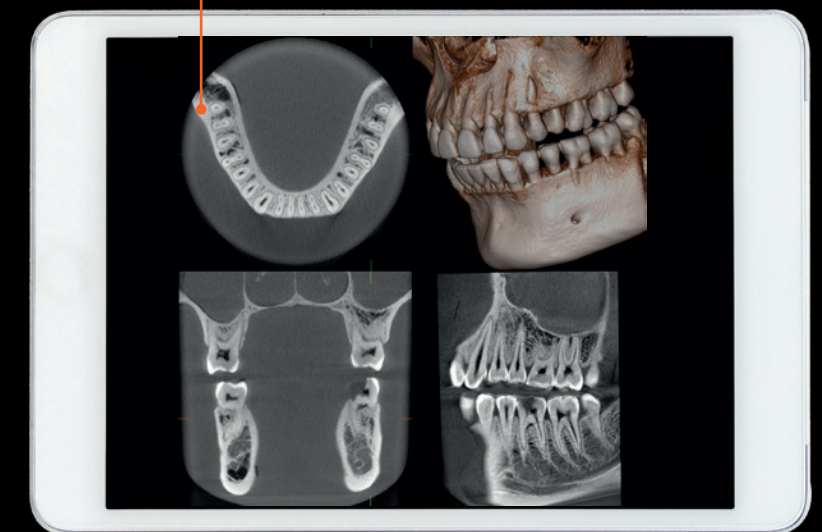

Precise positioning: Defining fields, imaging them precisely

The scout function lets you define the regions you want imaged, easily and precisely, before you take a partial 3D image.

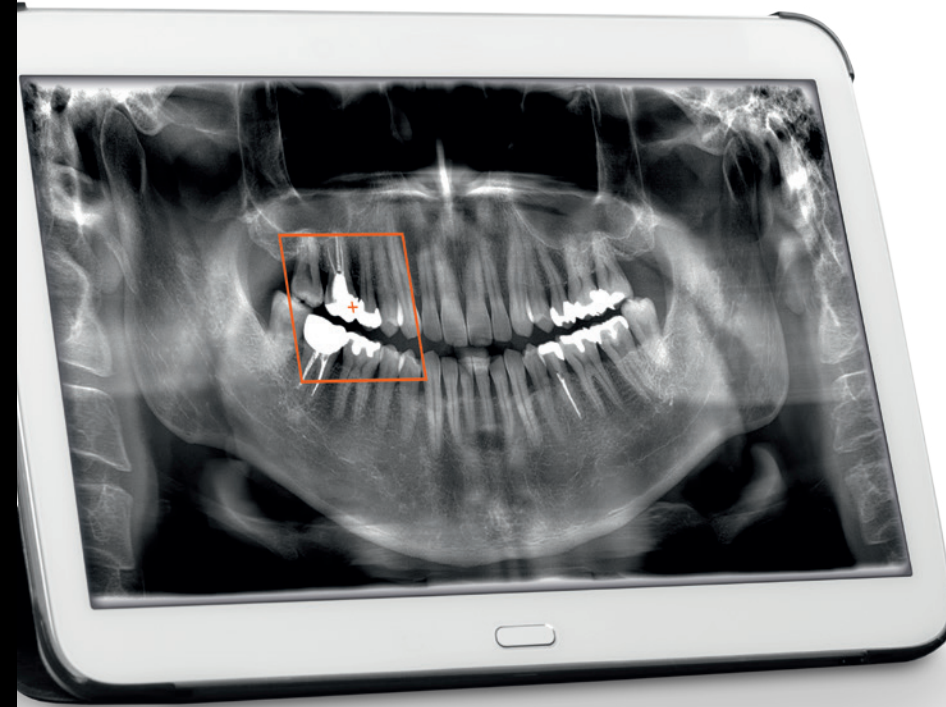

Panoramic Scout

By specifying the region of interest in a panoramic image, positioning and exposure for a limited field CBCT is very simple. This reduces the stress for the patient. After taking a CBCT exposure, double click on the cross mark in the panoramic image to display the CBCT data for that region.

Two-directional Scout

The region of interest is specified by taking lateral and frontal scout images. These images are used to accurately position for a limited field CBCT exposure.

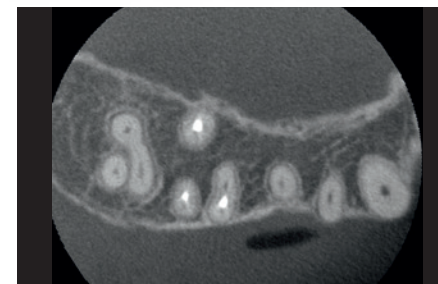
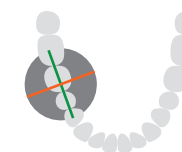

■ Axial section image



■ Sagittal section image



■ Frontal section image

Extra-sharp images: The smallest details at a glance

Sharp imaging plays a key role in patient health. The sharper the image, the more accurate the diagnosis – and the better and better-focused the treatment.

Sharp performance:

Peak values of 80 μm and 2.5 LP/mm

This is where the Veraview X800 is especially impressive, with an absolutely top performance and uncompromising resolution. Voxel size for images in the $\text{Ø} 40 \text{ mm} \times \text{H} 40 \text{ mm}$ field of view (FOV) is a surprising 80 μm – yielding a brilliant resolution of 2.5 LP/mm.

MTF (Modulation Transfer Function) is one way to objectively evaluate the line-pair resolution and objectively expresses how many line-pairs and at what level of contrast can be discriminated. Generally, if MTF is 10%, naked eye discrimination is possible. Spatial resolution does not depend only on voxel size.



A comparison shows just what that means. The extremely high resolution Veraview X800 image (voxel size 80 μm , resolution 2.5 LP/mm) is more detailed, with less artifacts.

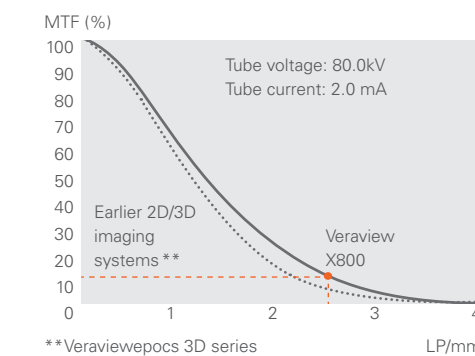

**Veraviewepocs 3D series

High resolution, voxel size 80 μm

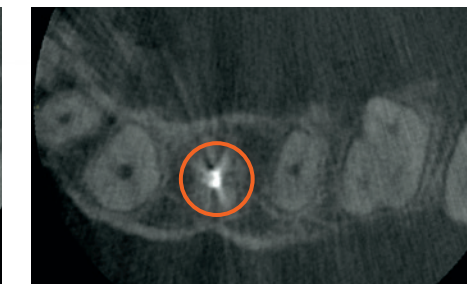
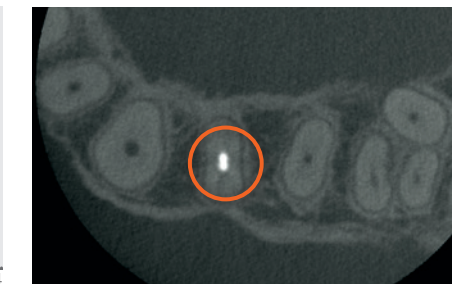

Standard, voxel size 125 μm **

Minimal artifacts: Best image quality for the most reliable diagnoses

For a clear diagnosis, you need a clear X-ray image. Artifacts in an image can mimic pathological alterations that can even lead to false findings. That's why it's so important to keep these "false positives" from showing up in the first place, and to smooth the way for an unambiguous, reliable diagnosis.

A clever concept: Horizontal X-ray beam

The Veraview X800 is designed from the start to keep artifacts and distortions to a minimum. That's possible because of the horizontal orientation of the X-ray beam, which produces top-quality CBCT exposures. If you shift the horizontal X-ray beam by 5°, you can suppress the interfering shadow of the hard palate in panoramic exposures.

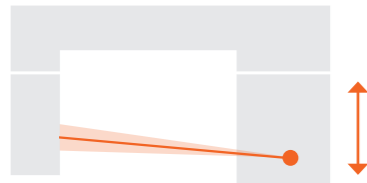

Clear as day: With CBCT exposures, the horizontal X-ray beam prevents artifacts typical of conventional methods with a raised beam from occurring at all.

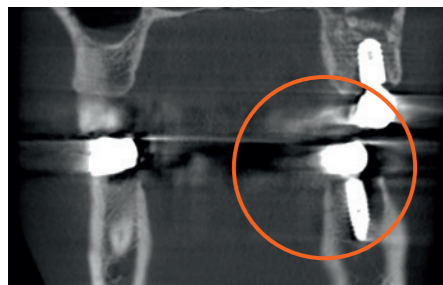

CBCT exposure with a horizontal beam

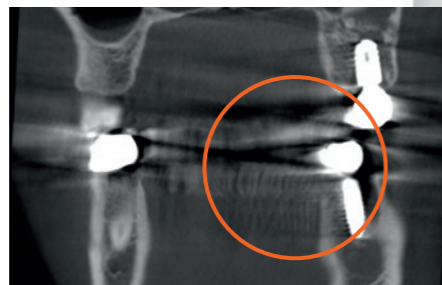

CBCT exposure with a raised beam



Flexibility wins: The Veraview X800 lets you choose between 360° and 180° exposures. You decide whether sharp detail or a low dose is a higher priority.

Sharper image or lower dose: 360° or 180° exposure

If you want to get the greatest possible detail, you can use the 360° mode. But depending on the indication, the 180° mode is also available, which entails a shorter exposure time and a lower radiation dose.

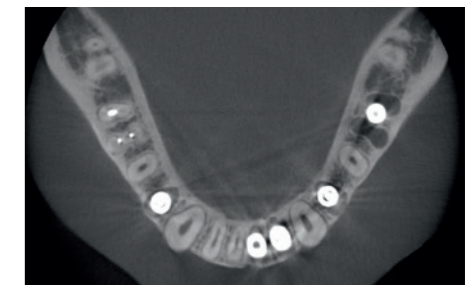

360° mode

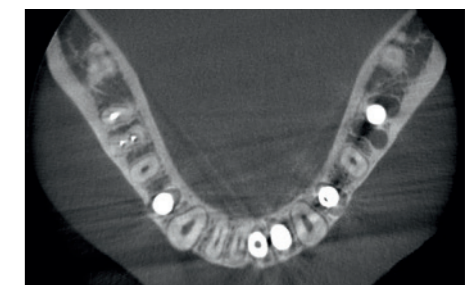

180° mode

Eleven fields of view: Always a perfect setting

With eleven fields of view (FOVs), the X-ray system provides the diagnostic confidence needed for planning a successful treatment. Following the ALARA principle (as low as reasonably achievable), you can choose the optimum FOV for your diagnostic issue. So you always have the best possible image of the region of interest – even as you minimize the radiation dose.

Field of view (FOV)	Voxel size	180° mode	360° mode	Type S	Type M	Type L
Ø 40 x H 40 High Res	0.080 mm					
Ø 40 x H 40	0.125 mm	✓	✓	✓	✓	✓
Ø 40 x H 80						
Ø 80 x H 40						
Ø 80 x H 50	0.125 mm	✓	✓	–	✓	✓
Ø 80 x H 80						
R 100 x H 40 ¹	0.125 mm					
R 100 x H 50 ¹		✓	–	–	✓	✓
R 100 x H 80 ¹						
Ø 150 x H 50 ²	0.320 mm					
Ø 150 x H 75 ²		–	✓	–	–	✓
Ø 150 x H 140 ³						

¹ R100: Dental arch FOV Ø 100 equivalent
² Employed data equivalent to 180° exposure
³ Two 360° exposures, upper and lower.
 Employed data equivalent to 180° exposure



New: Sharper reconstruction

Now, for the first time, there's a combined 2D/3D imaging system with a function for zoom reconstruction. From an image with a 125 µm voxel size, you can reconstruct a high-resolution image segment at 80 µm – without having to take another image. This function, however, is not available for the Ø 150 field of view (FOV).

Everything included:

Dental arch FOV function

A uniquely shaped field of view (FOV) with a Ø 100 mm encompasses the entire dental arch. The result: an image of the full dental arch at a low radiation dose.

Smart savings:

Dose reduction function

In areas with low bone density, the applied radiation is easily reduced. That makes it possible to lower the radiation dose to the patient by up to 40% compared to when the function is turned off.

Focused treatment plans:

11 selectable FOV

The broad range of eleven different FOVs answers every dental question – whether in implantology, periodontology, endodontology, oral surgery and orthodontics, or general dentistry.



Sharp panoramic images: Brilliant all around

Just for diagnostics or a dental implant – any successful extensive treatment plan relies on a full overview of the teeth and mandibular bone. The Veraview X800, with its numerous innovative functions, offers brilliant opportunities for excellent contrast and consistent high resolution.

Focus on high resolution:

The AFP function

The AFP (Adaptive Focal Point) function analyzes multiple layers of exposures. It checks each region, chooses the optimum panoramic layer, and recomposes them into a new image. The result: Everything in the image from the root apex to the incisor region is in perfect focus.

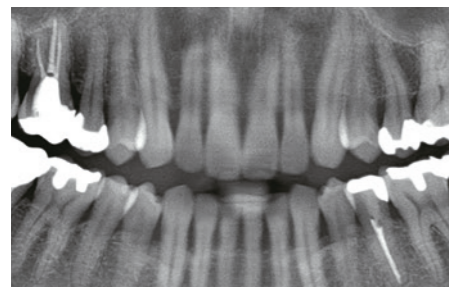

AIE-HD (without AFP)



AIE-HD (with AFP)

Real-time dose adjustment:

The DDAE function

With the DDAE (Digital Direct Auto Exposure) function, the flat panel detector detects X-ray transparency in real time during an exposure, and then adjusts the amount of X-rays emitted to create images with a significantly improved dynamic range.

The royal road: Combining multiple functions

A number of functions, including AFP, AGS, and AIE-HD, can be combined. The result is images that are consistently in precise focus and clearly show the regions of interest.

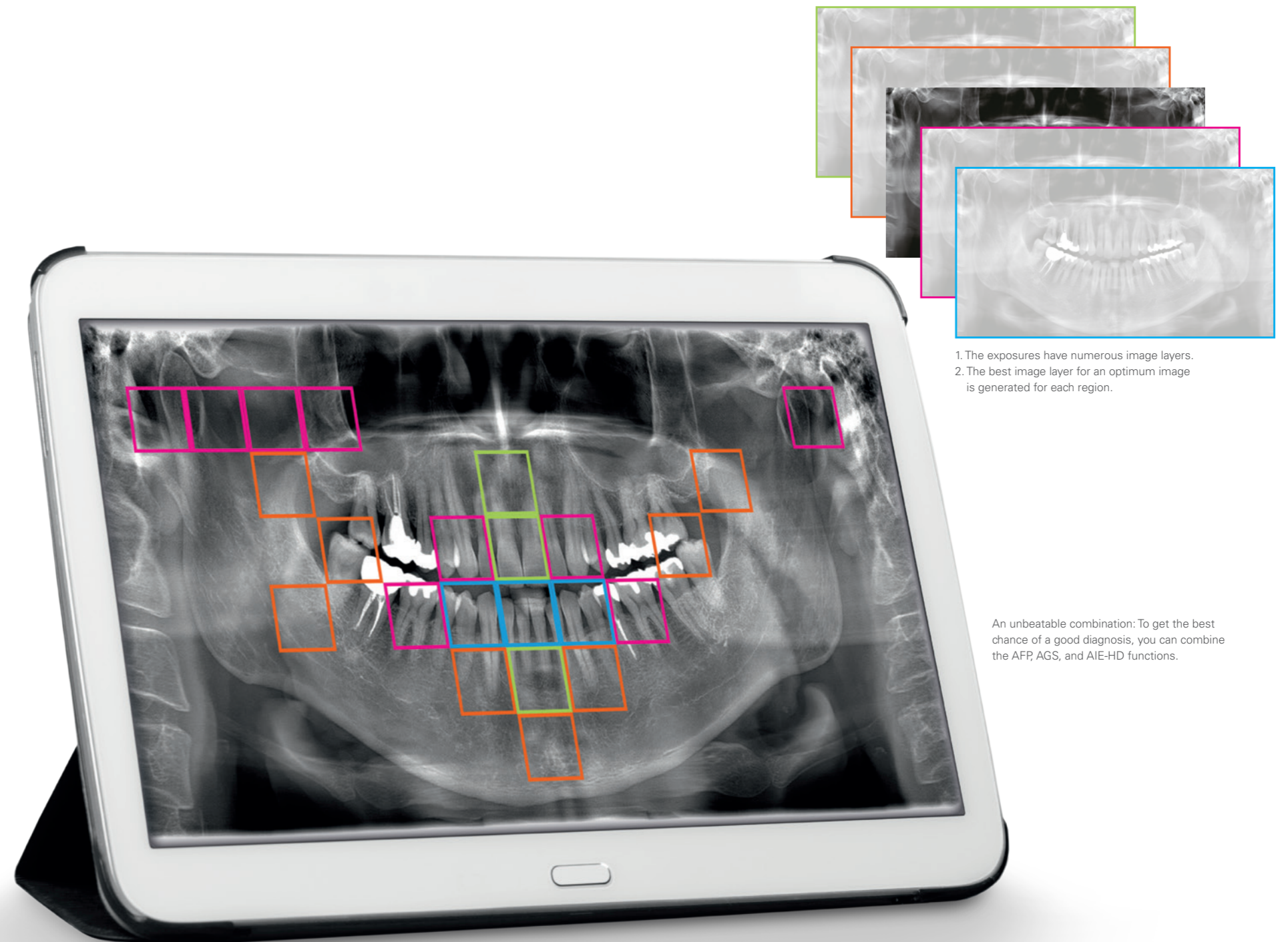

1. The exposures have numerous image layers.
2. The best image layer for an optimum image is generated for each region.

An unbeatable combination: To get the best chance of a good diagnosis, you can combine the AFP, AGS, and AIE-HD functions.



Face-to-face design: Communicating on the same level

One element of treatment that's often underestimated is communication with the patient – yet it's the foundation for a trusting doctor-patient relationship and can also make treatment procedures significantly easier. It's a point we factored in from the outset in designing the Veraview X800.

**Sharp contrast:
The AGS function**

The AGS (Adaptive Gray Scale) function automatically adjusts density to get the best possible contrast clear across the image. As a result, the entire panoramic image is clearly displayed – dental arch, mandibular bone, TMJ and more.

**Automatic optimization:
The AIE-HD function**

The AIE-HD (Auto Image Enhancement – High Definition) function optimizes panoramic image processing to make every detail sharp and clear.

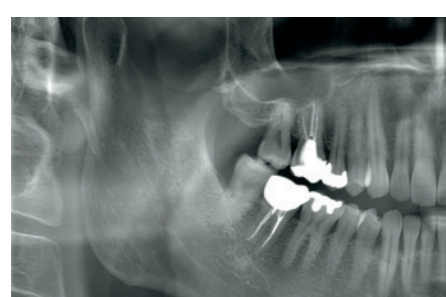

AFP + AIE-HD (without AGS)

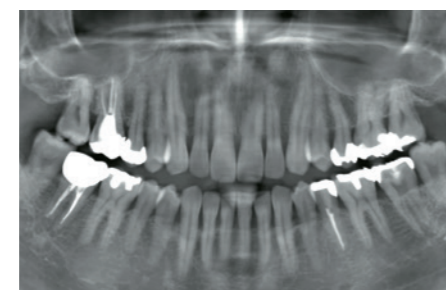

AFP + AGS (without AIE-HD)

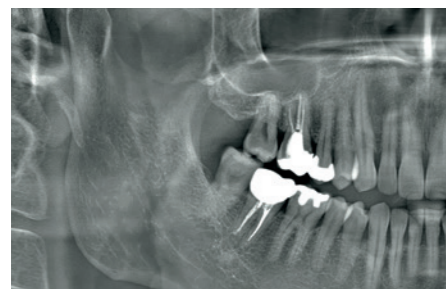

AFP + AIE-HD (with AGS)

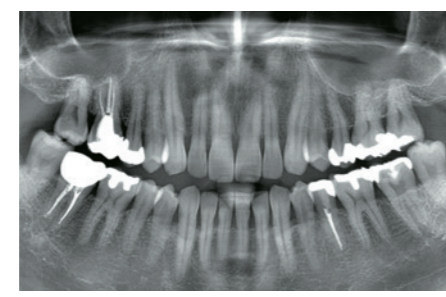

AFP + AGS (with AIE-HD)

Flexible:

A freely movable control panel

The control panel moves freely so it can be used from the front or side, making it easier to position the patient. You can easily set and check everything without taking your eyes off the patient.

Easy: Positioning for direct patient contact

Face-to-face positioning makes it easier both to communicate with the patient and to position the laser beam.

Intuitive: A pictogram user interface

The touch panel works intuitively and effortlessly using pictograms.

Comfortable: Adjustable chin rest for patients of any height

The Veraview X800 is meant to fit the patient – and not vice versa. That's why the chin rest can be lowered to as little as 1,005 mm. Which means that the X-ray system can be precisely adapted to patients of different heights, including those using a wheelchair.

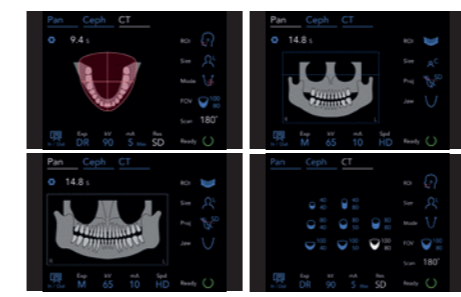

Easier treatments: Direct patient communication



Reduced doses: Less radiation – more protection

X-ray exposure has decreased dramatically since digital imaging systems were introduced – but patient health remains a core concern. That’s why we do all we can to keep reducing dose in order to provide the greatest possible protection. In 2D images especially, the Veraview X800 scores with many innovative features.

Smart and smaller: Collimated images

When you use the partial panoramic mode for 2D images, the focus is pared down to the essentials. The result: The region of interest is clearly visible, while the surrounding areas get a significantly lower dose.

Gentle to the little ones: Special children’s setting

The children’s setting for 2D images reduces irradiation time within the desired region. But grown-ups benefit too. Depending on how big the patient is, you can set the unit for a large, average, or small patient and thereby optimize the relationship between benefits and patient dose.

Also considered: A choice of three image layer orbits

No patient is exactly like any other – people differ not just in size but in many other ways, including the shape of the dental arch. That’s why the exposure layer for 2D images can be optimally adjusted to the patient’s dental arch. Three types of image layer orbits are available: narrow, standard, and wide.

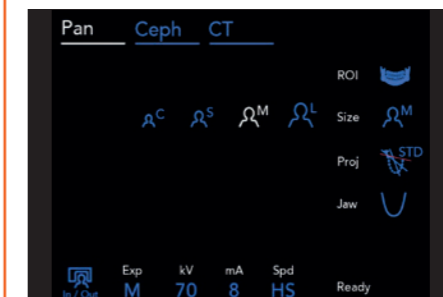

Custom tailored: Because you select the patient’s size, each person gets only the optimal dose for a good image.



Bite-wing exposure

To keep the exposed area small for 2D images, bite-wings can be chosen on only the left, the right or on both sides, depending on the indication.

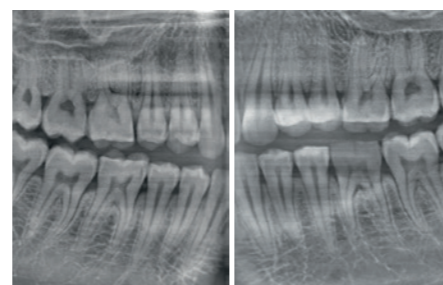

Well selected:

Partial cephalometric images

For cephalometric exposures, three regions can be selected individually in order to reduce the X-ray exposure for the patient. All the same, increasing tube voltage to 100 kV still allows high-quality exposures with a resolution of 96 µm.



Network integration: Well-networked everywhere

Good network integration and easy image display on a PC or tablet are important technical features that support smooth daily routines.

PC or tablet:

Images available everywhere

CBCT and 2D images can be displayed on any PC or tablet computer using a conventional web browser without installing any special software, which is convenient and helpful for patient consultation.



Technical specifications: Everything at a glance

Name:	Veraview X800
Model:	X800
Types:	F40 / R100 / F150
Rating:	AC 220 / 230 / 240 AC voltage; 50 / 60Hz
Power Consumption:	2,0 kVA
Weight:	Approx. 185 kg (approx. 220 kg with cephalometric)
Manufacturer:	J. MORITA MFG. CORP.
X-ray Tube Voltage:	60–100 kV (depending on exposure mode)
X-ray Tube Current:	2–10 mA (depending on exposure mode)
Nominal Focal Spot:	0.5
Panoramic Exposures:	High speed mode (standard panoramic) approx. 7.4 sec. Fine mode (standard panoramic) approx. 14.8 sec.
Panoramic Regions: (consistent magnification)	Standard Panoramic – standard, orthographic, shadowless Pedodontic Panoramic – standard, orthographic, shadowless Maxillary Sinus Panoramic – anterior, posterior Quadruple TMJ, partial panoramic, bite-wing exposure Distances measured on a panoramic image are not equal to the actual distances.
CBCT Exposure Time:	Approx. 9.4 sec. (180°) / approx. 17.9 sec. (360°)
CBCT Exposure FOV:	F40P / F40CP (cephalometric extension) - Ø 40 x H 40, Ø 40 x H 80 R100P / R100CP - Ø 40 x H 40, Ø 40 x H 80 - Ø 80 x H 40, Ø 80 x H 50, Ø 80 x H 80 - R 100 x H 40, R 100 x H 50, R 100 x H 80 F150P / F150CP - Ø 40 x H 40, Ø 40 x H 80 - Ø 80 x H 40, Ø 80 x H 50, Ø 80 x H 80 - R 100 x H 40, R 100 x H 50, R 100 x H 80 - Ø 150 x H 50, Ø 150 x H 75, Ø 150 x H 140
Direction and Size:	LA 220 x 250, PA 220 x 200 mm

Wear protective aprons and coverings as necessary during X-ray exposure. The unit must be fixed to the floor and wall when installed. If minimal layout dimensions are used, there may be very little space to move around inside the booth.

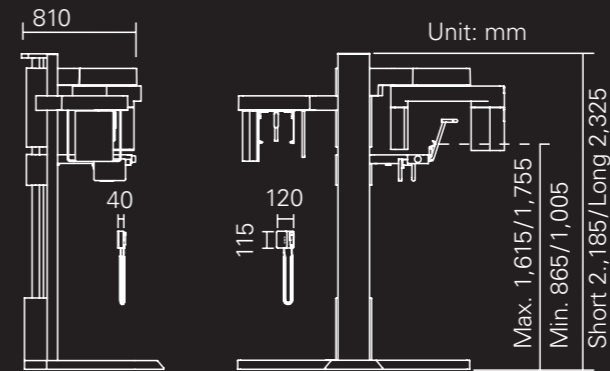

X800 - F40CP / R100CP / F150CP
(Panoramic, cephalometric and CBCT exposures)

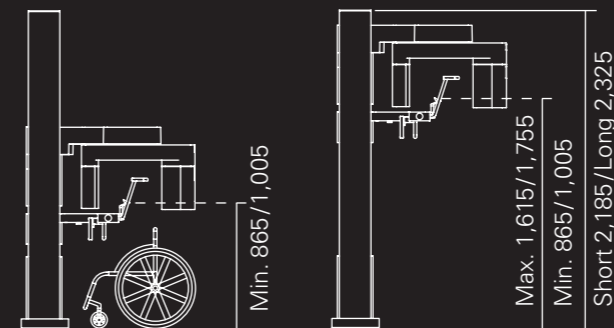

X 800 - F 40CP / R 100CP / F 150CP
(Panoramic, cephalometric and CBCT exposures)

