

MANUALE ISTRUZIONI
OPERATOR'S HANDBOOK
MANUEL D'UTILISATION
GEBRAUCHSANWEISUNG
MANUAL DE INSTRUCCIONES

MICRO
SMART
SUSTAINABLE PROGRESS

CATTANI
AIR TECHNOLOGY



MICRO SMART

SUSTAINABLE PROGRESS

INDICE

Dati generali di funzionamento aspiratore ad uso dentistico Micro-Smart	2
Introduzione	3
Segnali ed avvisi	3
Montaggio e messa in funzione	4
Manutenzione ordinaria	7
Manutenzione straordinaria	8
Istruzioni per muoversi e modificare alcuni parametri nei menù di Micro-Smart	9
Istruzioni per settare la comunicazione Zig-Bee (wireless).....	18
Descrizione allarmi	23
Avvisi importanti	24
Trasporto e stoccaggio	24
Trasporto di apparecchi usati	24
Illustrazioni.....	121

- Dati generali di funzionamento
Aspiratore ad uso dentistico Micro-Smart*

Modello	Micro-Smart
Tensione nominale	230 V ~
Frequenza nominale	50/60 Hz
Corrente nominale	6,3 A
Tipo di protezione contro i contatti diretti e indiretti	Classe I
Modalità di impiego	Funzionamento continuo
Protezione contro l'umidità	Comune
Grado di protezione contro i contatti diretti o indiretti	Tipo B
Potenza massima assorbita	1,30 kW
Portata massima	55 m ³ /h
Prevalenza massima per il servizio continuo	2100 mm H ₂ O
Pressione sonora versione scarenata da 60Hz a 120Hz	da 64 dB(A) a 71 dB(A)
Pressione sonora versione carenata in plastica del gruppo aspirante da 60Hz a 120Hz	da 63 dB(A) a 68,5 dB(A)
Pressione sonora versione carenata per interno da 60Hz a 120Hz	da 41 dB(A) a 48 dB(A)
Pressione sonora versione carenata per esterno da 60Hz a 120Hz	da 54,5 dB(A) a 61,2 dB(A)

~	Corrente alternata	IEC 417-5032
⊕	Terra di protezione	IEC 417-5019
⋈	Grado di protezione contro i contatti diretti o indiretti	CEI EN 60601-1
○	Aperto (sconnessione dalla rete di alimentazione)	IEC 417-5008
I	Chiuso (connessione alla rete di alimentazione)	IEC 417-5007

Livello di pressione sonora rilevato secondo la norma ISO 3746-1979 (E).
Parametri: r= 1,5 - rumore di fondo: 34 dB(A) - strumento Bruel & Kjaer type 2232.

- *Introduzione*
- *Segnali ed avvisi*

- **Introduzione**

La presentazione che segue ha lo scopo di illustrare il montaggio e la messa in funzione di Micro-Smart, e di informare circa i pericoli e le precauzioni utili alla prevenzione.

Il presente manuale deve essere sempre disponibile per consultazioni durante il montaggio, la messa in funzione, l'uso e la manutenzione del Vostro aspiratore Micro-Smart.

Nel sito Internet **www.cattani.it** sono rintracciabili i nostri manuali **aggiornati**.

Ne consigliamo la consultazione specialmente per gli aggiornamenti sulla **sicurezza**.

- **Segnali ed avvisi**

- *Pericolo di scosse elettriche: anche la 230 V \sim può risultare mortale.*



- *Pericolo biologico: infezioni da malattie epidemiche.*



- *Segnale generico di pericolo.*



- *Protezioni personali per lavori pesanti.*



- *Protezioni personali per pericolo biologico.*



- *Alta temperatura.*



- *Locale interdetto a sostanze infiammabili, corrosive od esplosive.*



- *Direzione obbligatoria del flusso o del senso di rotazione.*



Non sempre è possibile esprimere con un segnale gli avvisi di pericolo, è perciò necessario che l'utilizzatore legga gli avvisi e li tenga in debito conto.

Non rispettare un segnale od un avviso di pericolo, può causare danno all'operatore od al paziente.

Non rimuovere le protezioni antinfortunistiche, non modificare le macchine od il loro funzionamento.

Nonostante il nostro impegno è possibile che gli avvisi di pericolo non siano esaustivi, chiediamo venia all'utilizzatore, pregandolo nel contempo di prevedere egli stesso le fonti di pericolo che ci fossero sfuggite e darcene notizia.

• *Montaggio e messa in funzione*

• *Precauzioni raccomandate*

Prima di disimballare l'apparecchio, controllare l'esterno dell'imballo, fare attenzione all'indicatore di urti, trovando l'indicatore rosso, od il cartone danneggiato, accettarlo con riserva di controllare l'apparecchio.

Togliere la macchina dal cartone seguendo le istruzioni riportate all'esterno dell'imballo. Il cartone è riciclabile, si raccomanda di smaltirlo conformemente alle norme vigenti. Conservare i tappi che chiudono tutte le comunicazioni, esterno/interno dell'apparecchio, potranno essere utili nel caso si dovesse spostare l'aspiratore.

Il montaggio dell'apparecchio deve essere eseguito da persona esperta ed attrezzata. L'aspiratore deve essere posizionato in ambiente pulito, lontano da fonti di calore, dall'umidità e dalla polvere. Nei montaggi esterni: balconi, verande e giardini, proteggere le macchine dalla pioggia, dall'umidità, dal gelo e dall'esposizione diretta ai raggi del sole.

Segnaliamo in proposito la carenatura per esterni di Micro – Smart completa di: doppio tetto isolante, impianto antigelo ed impianto di ventilazione, entrambi con termostato fisso per la regolazione automatica della temperatura.

La temperatura ambiente del locale tecnico non deve essere inferiore ai + 5 °C e non deve essere superiore ai + 35 °C.

Le macchine carenate, per interno e per esterno, possono essere ordinate complete di impianto antigelo. Dove fosse necessario ventilare o condizionare la sala macchine, è consigliabile far progettare l'impianto di ventilazione o di condizionamento da un termotecnico. Il locale tecnico non deve essere accessibile ai pazienti od ai passanti. Quando non sia disponibile tale locale è necessario che le macchine siano protette da una carenatura non facilmente asportabile. Pre-disporre protezioni e cartelli indicatori di pericolo, in modo da evitare contatti accidentali, pericolosi per le scosse elettriche, e per la possibilità (remota ma non escludibile) d'incendio, di scoppio, per la fuoriuscita di aria e di liquidi contaminanti. Servirsi esclusivamente di carenature (per interni e per esterni) studiate e costruite dal fabbricante.

Nel locale tecnologico non deve sostare materiale infiammabile, verificare che non vi sia la possibilità di fughe di gas. Non si debbono allacciare alla rete elettrica apparecchi danneggiati; non utilizzare prolunghe, prese o spine multiple. Prima di collegare l'apparecchio alla linea elettrica, controllare che questa sia conforme alle norme C.E.I. 64-8 e che sia presente un interruttore magnetotermico con differenziale (16A) in classe "A" o "B" secondo le norme EN 61008-1. I pavimenti di colore chiaro, in legno, linoleum, gomma o marmo, a contatto dei piedini antivibranti in gomma **(1)** possono cambiare colore e rimanere segnati; isolare perciò gli antivibranti dal pavimento con un foglio di plastica o di altro materiale adatto.

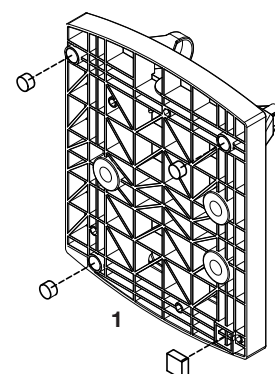
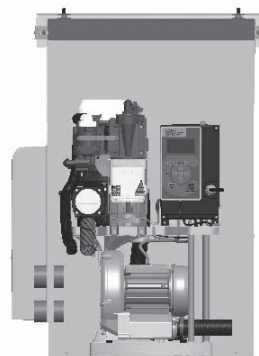
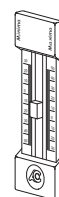
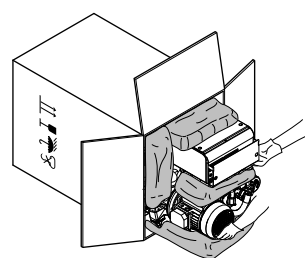

• Montaggio

Prima di collegare l'aspiratore alla canalizzazione dell'impianto centralizzato, accertarsi che le tubazioni aspiranti siano pulite, i detriti pesanti potrebbero danneggiare l'apparecchio.

Il tubo di aspirazione (in PVC **(3)** di colore grigio chiaro in dotazione all'apparecchio) deve essere collegato al portatubo **(2)** diametro 30 mm "ingresso fluido aspirato". Dalla parte opposta lo stesso tubo si collegherà alla canalizzazione aspirante **(2b)** in arrivo dalle sale operatorie.

Il tubo per l'aria espulsa **(4b)** (di colore nero, resistente alla temperatura, con spirale metallica) deve essere collegato al portatubo **(4)** diametro 30 mm "uscita aria espulsa", l'altra estremità del tubo verrà collegata al filtro antibatterico **(5)** passando preferibilmente attraverso un silenziatore **(5a)** sempre in dotazione all'aspiratore. All'uscita dal filtro antibatterico, l'aria espulsa ancora calda, dovrà essere convogliata all'esterno.

Il portatubo **(6, pag. 7)**, diametro 18 mm andrà collegato al tubo di scarico dei liquidi, si consideri che quando è presente l'Idrociclone l'aspiratore drena per caduta e che in nessun caso può scaricare verso l'alto. Il portatubo **(8, pag. 6)** diametro 10 mm "scarico d'emergenza" deve essere collegato al tubo di scarico liquidi. Il portatubo **(6b)** diametro 11mm andrà collegato al tubo di scarico quando non è presente l'Idrociclone. I tubi di collegamento che uniscono la macchina all'impianto di aspirazione e di drenaggio sono flessibili per ammortizzare le piccole vibrazioni indotte dal funzionamento dell'aspiratore.

La canalizzazione aspirante corre generalmente nel pavimento, in prossimità dell'aspiratore sale per circa 30 cm sino a raggiungere il portatubo **(2)** (fig. A e B, pag. 121).

Anche quando Micro-Smart è sistemato ad un piano inferiore rispetto agli studi, la canalizzazione aspirante deve scendere dalla sala operatoria al piano dell'aspiratore, compiere un percorso di qualche metro in piano sul pavimento e salire con un tubo flessibile sino al separatore centrifugo (fig. B, pag. 121), il fluido aspirato verrà risucchiato dall'aspiratore.

Terminato il montaggio si dovrà collegare il cavo di alimentazione alla linea elettrica dell'ambiente secondo la normativa EN 61008-1.

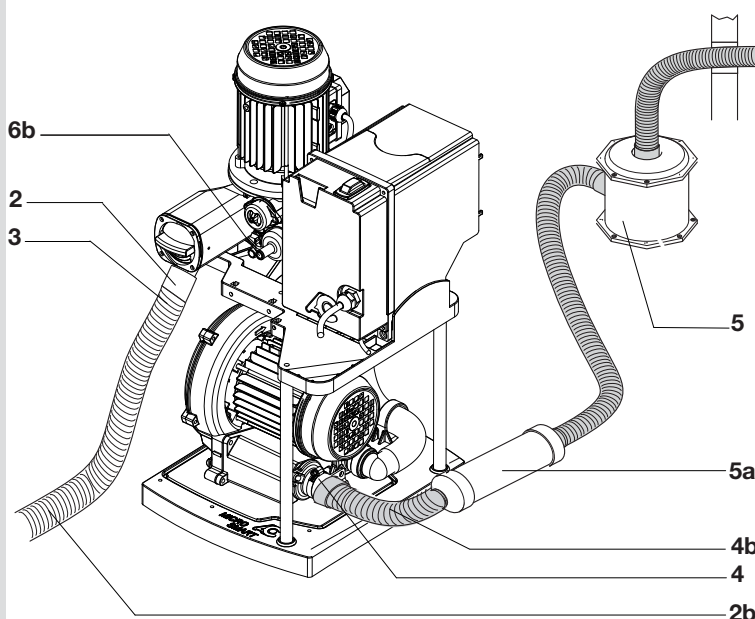
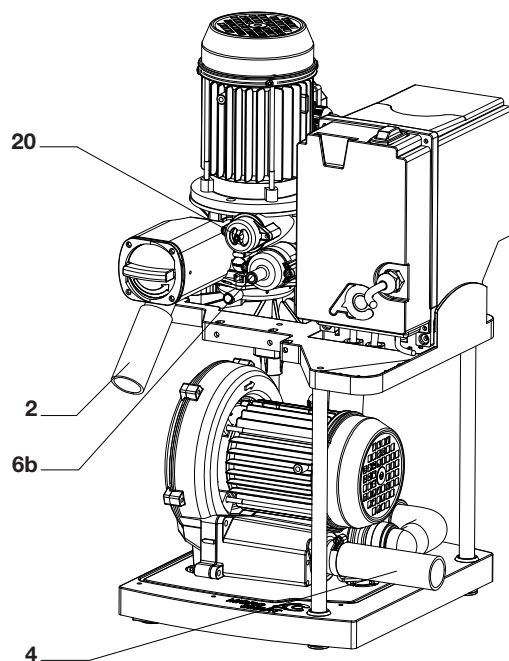

Da ultimo si collegherà la linea dei consensi a bassa tensione che collega il riunito al suo aspiratore, accertarsi che si tratti di un contatto pulito (non in tensione).

- **Messa in funzione, collaudo ed istruzione del personale.**

Una volta montato e collegato elettricamente l'aspiratore, basterà premere il pulsante acceso/spento e far partire il segnale del consenso da uno dei riuniti collegati, perché abbia inizio l'aspirazione.

Per verificare il corretto funzionamento dell'aspiratore Micro-Smart, è consigliabile effettuare i test di tipo dinamico (esposti alla fig. E, pag. 124) e consultare il diagramma di lavoro di Micro-Smart, fig. F pag. 125.

L'istruzione del personale per l'uso e la manutenzione ordinaria dell'aspiratore va fatta ad apparecchio nuovo non ancora contaminato.

Il personale dello studio deve essere istruito a seguire sul display le fasi di funzionamento di Micro-Smart, ad interpretare gli avvisi di pericolo ed a fare una corretta manutenzione con Puli-Jet plus new (A), Pulse-Cleaner (B) e ad usare regolarmente le pastiglie antischiumogene (C).

- **Funzionamento**

Il gruppo aspirante (9) (attraverso il tubo 10) crea la depressione nel separatore centrifugo (11). Il fluido proveniente dagli studi, attraverso il tubo collettore (2) entra nel separatore centrifugo (11).

Il separatore centrifugo separa l'aria dai liquidi: l'aria viene espulsa all'esterno attraverso il tubo (4) mentre i liquidi vengono drenati in fognatura attraverso il tubo di scarico collegato al portatubo (6b) quando non è presente l'Idrociclone e 6 con la presenza dell'Idrociclone.

La partenza del separatore centrifugo (part. 11) è anticipata rispetto alla turbina (part. 9), tale vantaggio consente di espellere i liquidi, eventualmente accumulati nel separatore centrifugo, prima che abbia inizio l'aspirazione. Inoltre allo spegnimento della macchina, un temporizzatore regolabile terrà in moto l'aspiratore da 10 a 120 secondi.

- **Il separatore di amalgama a norme ISO 11143**

Micro-Smart può essere ordinato completo del separatore di amalgama "Idrociclone ISO 5,5l/min."

Il separatore di amalgama è sempre accompagnato dal manuale istruzioni e manutenzione.

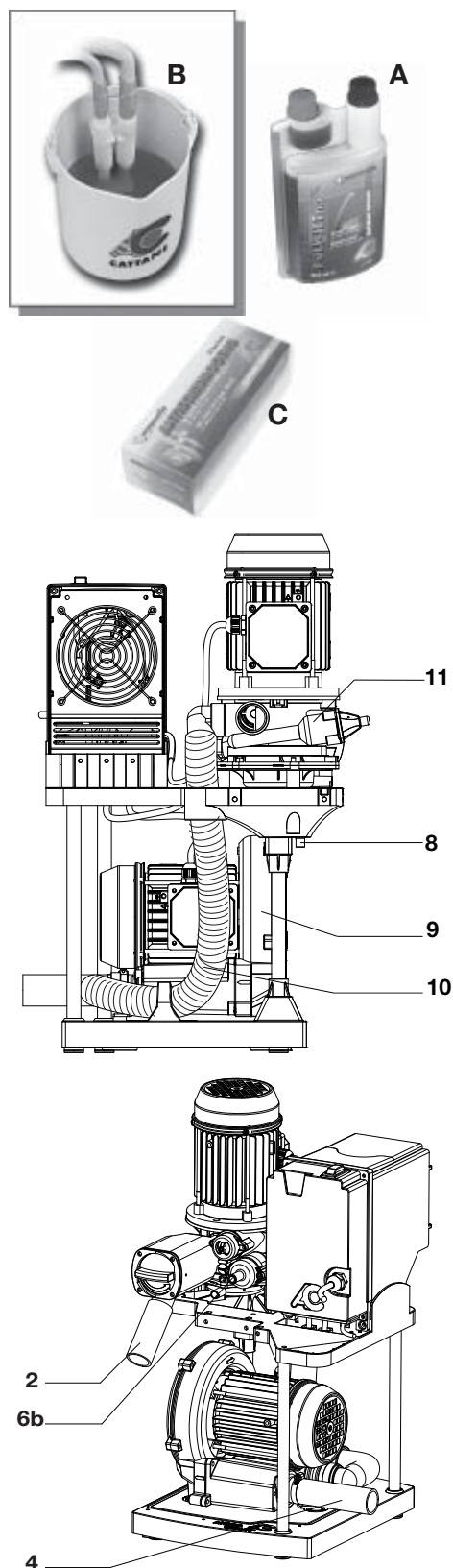

• *Manutenzione ordinaria*

La manutenzione ordinaria deve essere affidata al personale dello studio appositamente istruito.

- Si raccomanda di fare particolare attenzione a tutti i segnali di pericolo e di proteggersi con occhiali, guanti e grembiule monouso.

Ogni giorno (specialmente a fine giornata, più volte al giorno secondo la necessità)

- Controllare sul display le eventuali segnalazioni di allarmi, in presenza di avvisi di pericolo mettersi in contatto con il tecnico.
- Aspirazione serale di una soluzione di Puli-Jet plus new disinfettante con anticalcare **(A)** con Pulse Cleaner **(B)**;
- Pulire i filtri dell'aspirazione sul riunito, recuperare i rifiuti secondo le normative vigenti, specialmente se si tratta di amalgama, e posizionare negli stessi filtri le pastiglie anti-schiumogene disinfettanti **(C)**.
- **Prima di avvicinarsi all'aspiratore, togliere corrente.**
- Pulire il filtro dell'aspiratore.

Saltuariamente secondo le necessità

- Controllare che non si formino ostacoli alla libera ventilazione dell'aspiratore;
- Tenere libero il locale tecnologico da quanto non attiene alle stesse macchine, con particolare riferimento a materiale infiammabile, sorvegliare che non vi sia la possibilità di formazione di miscele corrosive, infiammabili od esplosive.



ALLARME:
TEMPERATURA ELEVATA

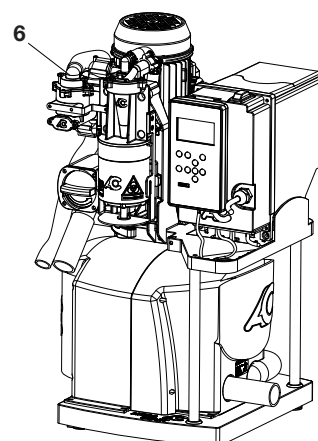
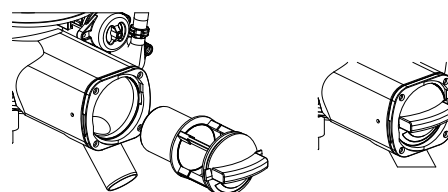
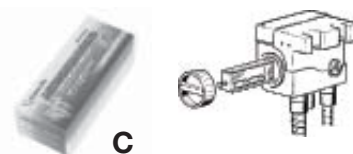
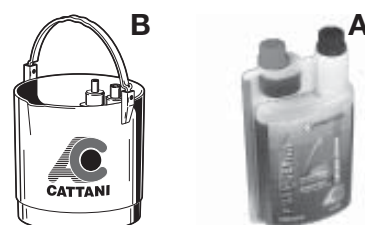

• *Manutenzione straordinaria*

La manutenzione straordinaria va affidata ad un tecnico preparato ed in possesso dei ricambi originali.

- Fare particolare attenzione a tutti i segnali di pericolo e proteggersi con occhiali, guanti e grembiule monouso.
- Controllare lo stato di manutenzione ordinaria, verificare che si usino prodotti Magnolia.
- Prima di intervenire sugli apparecchi fare alcuni lavaggi con Fast&Steril 3 (D), aspettare 15 minuti perché l'azione disinfettante abbia svolto il suo effetto.

Controlli consigliati ogni 12 mesi *

- Controllare le temperature massime registrate e tutti i segnali di allarme, intervenire di conseguenza.
- In presenza di precaria manutenzione ordinaria o dell'uso di prodotti impropri, istruire il personale ed informare il responsabile dello studio. Gli apparecchi trattati con prodotti diversi da quelli consigliati non sono considerati in garanzia.
- Controllare la rumorosità dell'aspiratore, vedere pag. 2.
- Con un getto d'aria asciutta che non superi la pressione di 2 bar, pulire il ventilatore ed il dissipatore del centralino elettrico e con una pressione di 6 bar pulire i forellini sul coperchio frontale del gruppo aspirante (15);

Controlli consigliati ogni 18-24 mesi

- Controllare i tubi in plastica, in modo particolare quelli in pressione (all'uscita del separatore centrifugo part. 11 e prima dell'Idrociclone ISO) dei quali consigliamo la sostituzione ogni 18-24 mesi.
- Controllare le condizioni di funzionamento del separatore centrifugo (11) e della valvola di ricircolo (14).

Controlli consigliati ogni 10.000/15.000 ore

- Sostituire i particolari in gomma (OR, soffietti, guarnizioni/tenute) particolari che vanno sostituiti anche ogni volta che si interviene smontando il particolare che interessa la tenuta.
- Sostituire i cuscinetti dei motori.

(*) I tempi d'intervento sono indicativi: in presenza di locali polverosi o di particolare intensità di lavoro, aumentare gli interventi secondo le necessità.



CAUTION
Temperatura elevata
Extremely hot surface

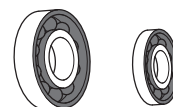
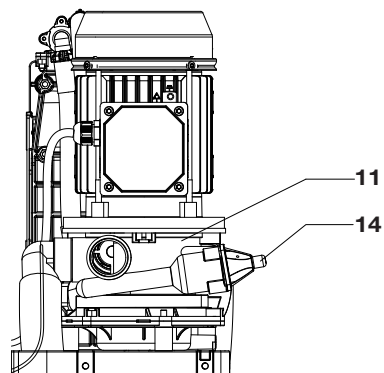
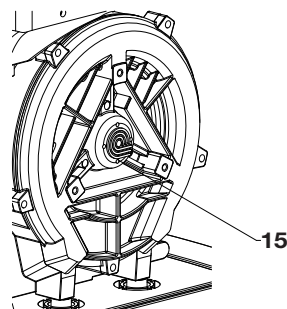

• Istruzioni per muoversi e modificare alcuni parametri nei menù di Micro-Smart

Menù principali

All'accensione di Micro-Smart, il display grafico mostra per 10 secondi il logo della Cattani S.p.A., al termine del quale apparirà il menù principale.



Menù principale "A1"

Sono visibili alcuni parametri come la frequenza d'esercizio, il tempo di attivazione dell'aspiratore, la temperatura, il contenitore d'amalgama (se presente) e la revisione software del sistema.

Premendo la freccia a destra  si accede al

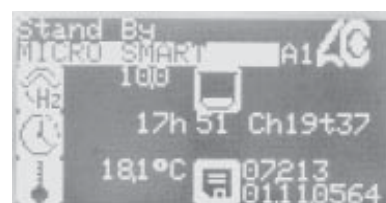

Menù di controllo "A2"

Sono visibili: il numero di volte che Micro-Smart è stato acceso, le ore di accensione totali, il numero di attivazioni dell'aspiratore, le ore effettive di utilizzo dell'aspiratore, le ore di lavoro in rapporto alla frequenza e il numero di attivazioni del ventilatore.

Freccia a destra 

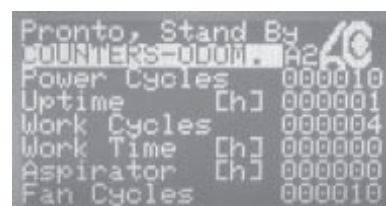

Menù degli eventi "A3"

Sono visibili gli ultimi eventi o allarmi occorsi a Micro-Smart. Gli eventi sono indicati da un numero, per la decodifica riferirsi alla tabella a pag. 23.

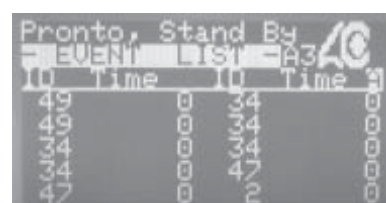

Menù di controllo "A2"

COUNTERS - ODOM . A2		
POWER CYCLES	000000	Numero di accensioni da interruttore generale
UPTIME [h]	000000	Ore totali di accensione (con motori fermi)
WORK CYCLES	000000	Numero di attivazioni da comando aspirazione
WORK TIME [h]	000000	Ore di lavoro effettive (motori in funzione)
ASPIRATOR [h]	000000	Ore di lavoro in rapporto alla frequenza
FAN CYCLES	000000	Numero di attivazioni della ventola di raffreddamento del centralino

Menù secondari

Premendo  si accede ai menù secondari.

Da questo menù si accede ai seguenti premendo la freccia in basso



Drive Status

A questo menù si accede senza alcuna "Password", si possono qui visualizzare utili informazioni sul funzionamento.

User Parameters

Si accede digitando la password "0000123000".

E' possibile modificare il livello di vuoto, la lingua e tutti i livelli di prestazioni nelle diverse configurazioni.

System Parameters Setup

Si accede digitando la password "0000456000".

E' possibile modificare il ritardo allo spegnimento, ed altri parametri di tipo tecnico.

Factory Settings Restricted Access

Menù non accessibile, di esclusivo utilizzo dell'azienda Cattani.

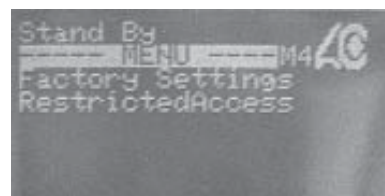
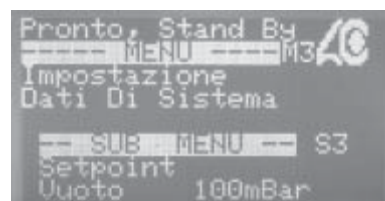
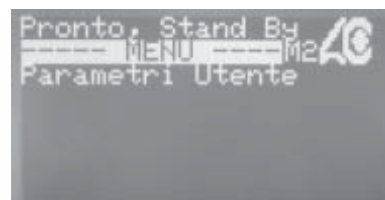
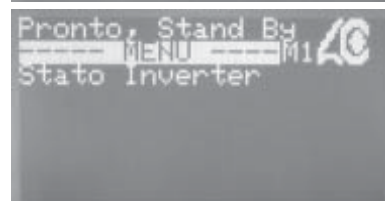
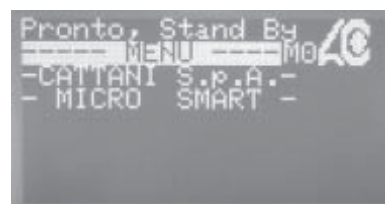
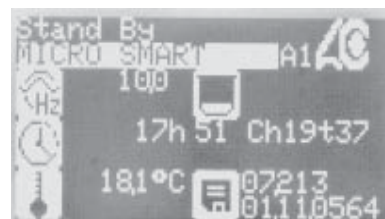

scroll down button





Come entrare e digitare la "Password"

Drive Status è il solo menù consultabile senza l'utilizzo di alcuna "Password".

Per entrare nei menù "User Parameters" e "System Parameters Setup" inserire obbligatoriamente le "Password":

"Password" di accesso al menù "User Parameters" "0000123000".



"Password" di accesso al menù "System Parameters Setup" "0000456000".



Dal menù "CATTANI S.p.A.", premere la freccia  quindi la freccia  sul display apparirà il menù "Access Password" 0000000000

Premendo il tasto Enter  apparirà il cursore sullo 0 a destra.

Premendo  spostare il cursore sul sesto 0.

Premendo  apparirà 1.

Premere  spostarsi allo 0 a fianco e con  scrivere 2.

Premere  spostarsi allo 0 a fianco e con  scrivere 3.

Premere il tasto Enter  per confermare la "Password" ed il cursore sparirà.

Premere  per tornare al menù "Cattani S.p.A.".

Ora sarà possibile modificare i parametri del menù "User Parameters"

Ripetere la stessa procedura per inserire la password 0000456000 ed accedere alle modifiche del menù "System Parameters Setup".

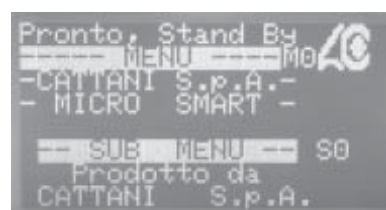
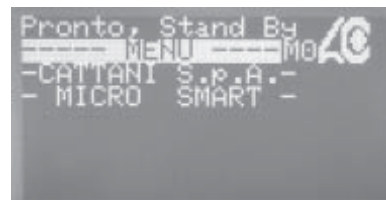

Menù "Drive Status"

Questo menù è visibile senza l'inserimento di alcuna password, ed ha la funzione di rendere visibili alcuni parametri sullo stato di funzionamento di Micro-Smart, di seguito sono indicati alcuni di questi parametri.

Frequenza soffiante (max. 120 Hz)

Tensione uscita soffiante (max. 220 V)

Corrente soffiante (max. 4,3 A)

Frequenza separatore centrifugo (75 Hz non variabili)

Tensione uscita separatore centrifugo (max. 220V)

Corrente separatore centrifugo (max. 3,2 A)

scroll down button
↓

```
Pronto, Stand By
----- MENU ----- M1 AC
Stato Inverter
```

```
Pronto, Stand By
----- MENU ----- M1 AC
Stato Inverter

-- SUB MENU -- S0
FrequenzaAttuale
Soffiante 0100Hz
```

```
Pronto, Stand By
----- MENU ----- M1 AC
Stato Inverter

-- SUB MENU -- S1
Tensione Uscita
Soffiante 029[V]
```

```
Pronto, Stand By
----- MENU ----- M1 AC
Stato Inverter

-- SUB MENU -- S2
Corrente
Soffiante 000A
```

```
Pronto, Stand By
----- MENU ----- M1 AC
Stato Inverter

-- SUB MENU -- S3
Frequenza Uscita
Centrifuga 100Hz
```

```
Pronto, Stand By
----- MENU ----- M1 AC
Stato Inverter

-- SUB MENU -- S4
Tensione Uscita
Centrifuga037[V]
```

```
Pronto, Stand By
----- MENU ----- M1 AC
Stato Inverter

-- SUB MENU -- S5
Corrente
Centrifuga 000A
```

Temperatura del sistema

Massima temperatura registrata (60 °C allarme e blocco aspiratore resettabile)

Massima temperatura registrata (60 °C memoria temperatura non resettabile)

Tensione di bus (max. 390 V)

Massima tensione di bus memorizzata (max. 390 V)

Tensione di ripple bus

Livello di vuoto istantaneo (max. 210 mbar)

```
Pronto, Stand By
----- MENU ----- M1 AC
Stato Inverter

-- SUB MENU -- S6
Temperatura
Dissipatore 34,8°C
```

```
Pronto, Stand By
----- MENU ----- M1 AC
Stato Inverter

-- SUB MENU -- S7
Massima Temperat
Memorizzata 36,2°C
```

```
Pronto, Stand By
----- MENU ----- M1 AC
Stato Inverter

-- SUB MENU -- S8
Massima Temperat
Assoluta 36,2°C
```

```
Pronto, Stand By
----- MENU ----- M1 AC
Stato Inverter

-- SUB MENU -- S9
Tensione Bus
Potenza 309 U
```

```
Pronto, Stand By
----- MENU ----- M1 AC
Stato Inverter

-- SUB MENU -- S10
Massima Tensione
BUS Memoriz. 323U
```

```
Pronto, Stand By
----- MENU ----- M1 AC
Stato Inverter

-- SUB MENU -- S11
Ripple Bus
Potenza 000 U
```

```
Pronto, Stand By
----- MENU ----- M1 AC
Stato Inverter

-- SUB MENU -- S12
Livello Vuoto
-01 mBar
```

scroll down button



Modo funzionamento (descrive come deve lavorare la macchina)

Menù "User Parameters"

A questo menù, si accede inserendo la "Password di Accesso" 0000123000 (vedi istruzioni a pag. 11).

Vacuum set point - Livello di vuoto-



Mostra il livello massimo di vuoto impostato.

Premere  Enter per modificare, con le frecce   impostare il valore desiderato.

Premere  Enter per confermare la modifica.

Language - Lingua -

È possibile selezionare Inglese (1), Italiano (0), Francese (2) e Tedesco (3).

Premere  Enter e con le frecce   selezionare 0 o 1 o 2 o 3.

Premere  Enter per confermare la modifica.

Generated code - Codice generato -

Questo codice è generato dalla Cattani S.p.A.. Ogni apparecchiatura ha un codice unico che per il momento non ha nessun tipo di utilizzo

Activation code - Codice di attivazione -

Questa finestra al momento non è utilizzabile

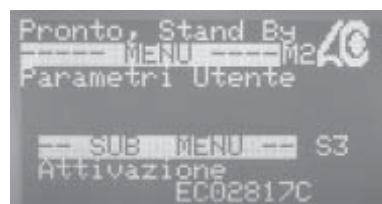
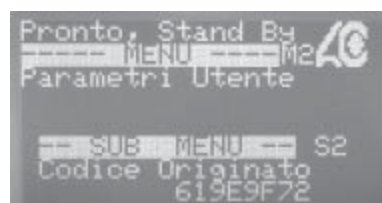
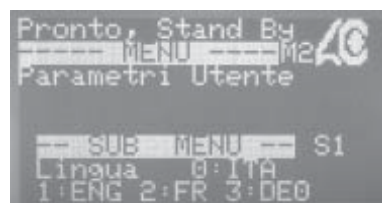
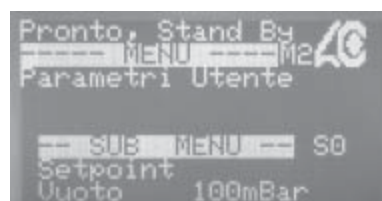
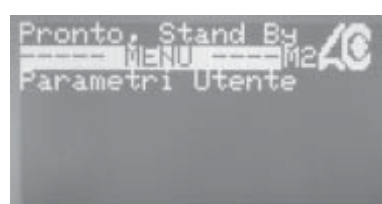
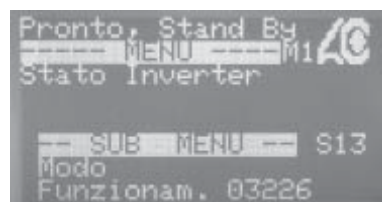



scroll down button

Menù "System Parameters Setup"

A questo menù, si accede inserendo la "Password di Accesso" 0000456000 (vedi istruzioni a pag. 11).

Sarà ora possibile modificare alcune impostazioni.

Per cambiare i parametri in questo menù: Scorrere le pagine dei menù con le frecce  per evidenziare i parametri da modificare.

Premere  Enter per attivare il cursore, con le frecce

 impostare il valore desiderato.

Premere  Enter per confermare la modifica.

Tutti i parametri possono essere regolati:

Livello di vuoto minimo

Massima frequenza soffiante per il livello di vuoto minimo

Limite corrente soffiante per il livello di vuoto minimo

Livello di vuoto medio

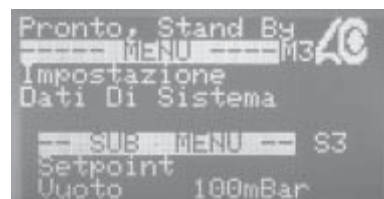
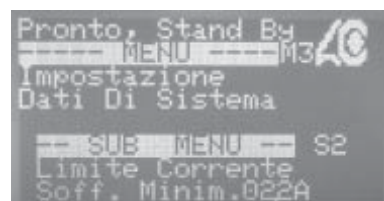
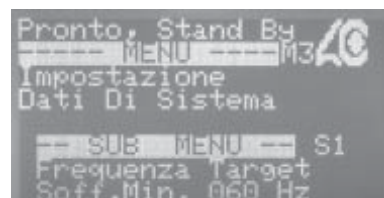
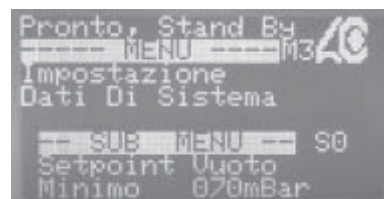

scroll down button



Massima frequenza soffiante per il livello di vuoto medio

Limite corrente soffiante per il livello di vuoto medio

Livello di vuoto chirurgico

Massima frequenza soffiante per il livello di vuoto chirurgico

Limite corrente soffiante per il livello di vuoto chirurgico

Ritardo spegnimento (max. 300 S)

Ritardo spegnimento pompa (max. 30 S)

```
Pronto, Stand By
----- MENU ----- M3 AC
Impostazione
Dati Di Sistema

--- SUB MENU --- S4
Frequenza Target
Soffiante 085 Hz
```

```
Pronto, Stand By
----- MENU ----- M3 AC
Impostazione
Dati Di Sistema

--- SUB MENU --- S5
Limite Corrente
Soffiante 025A
```

```
Pronto, Stand By
----- MENU ----- M3 AC
Impostazione
Dati Di Sistema

--- SUB MENU --- S6
Setpoint Vuoto
Chirurg. 210mBar
```

```
Pronto, Stand By
----- MENU ----- M3 AC
Impostazione
Dati Di Sistema

--- SUB MENU --- S7
Frequenza Target
Chirurgica100 Hz
```

```
Pronto, Stand By
----- MENU ----- M3 AC
Impostazione
Dati Di Sistema

--- SUB MENU --- S8
Limite Corrente
Soff. Chir. 035A
```

```
Pronto, Stand By
----- MENU ----- M3 AC
Impostazione
Dati Di Sistema

--- SUB MENU --- S9
Ritardo
Spegnim. 010s
```

```
Pronto, Stand By
----- MENU ----- M3 AC
Impostazione
Dati Di Sistema

--- SUB MENU --- S10
Ritardo Spegnim.
Pompa 05000t
```

↓
Scroll down button

Ritardo spegnimento ventola (max. 300 S)

Opzioni Utilizzate

Abilita o disabilita la lettura del sensore di amalgama.

- 0- senza separatore di amalgama
- 2- con separatore di amalgama

Comandi ad inverter.

Riservato a regolazioni in fabbrica

Modbus Address

Questo menù non è al momento utilizzato.

Network Address

Si specifica l'indirizzo di rete del Micro-Smart per la visualizzazione Zig-Bee

Zig-Bee Channel Minimum

Si determina su quale numero di canale minimo deve comunicare il Micro-Smart

Zig-Bee Channel Maximum

Si determina su quale numero di canale massimo deve comunicare il Micro-Smart

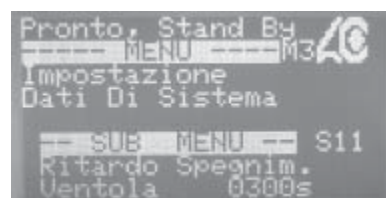

```

Pronto, Stand By
----- MENU -----M3
Impostazione
Dati Di Sistema

-- SUB MENU -- S11
Ritardo Spegnim.
Ventola 0300s
  
```

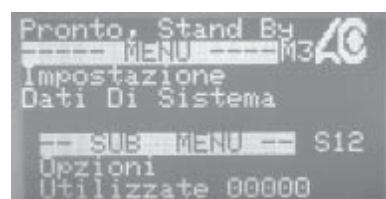

```

Pronto, Stand By
----- MENU -----M3
Impostazione
Dati Di Sistema

-- SUB MENU -- S12
Opzioni
Utilizzate 00000
  
```

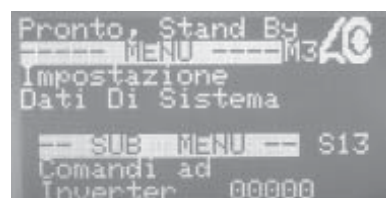

```

Pronto, Stand By
----- MENU -----M3
Impostazione
Dati Di Sistema

-- SUB MENU -- S13
Comandi ad
Inverter 00000
  
```

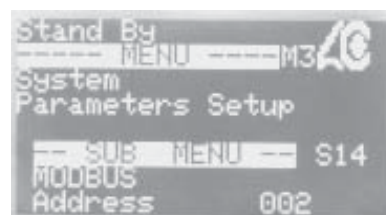

```

Stand By
----- MENU -----M3
System
Parameters Setup

-- SUB MENU -- S14
MODBUS
Address 002
  
```



```

Stand By
----- MENU -----M3
System
Parameters Setup

-- SUB MENU -- S15
Network
Address 104
  
```

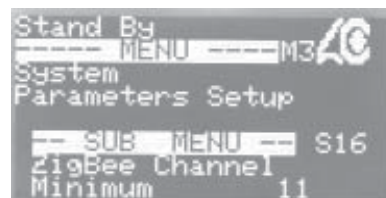

```

Stand By
----- MENU -----M3
System
Parameters Setup

-- SUB MENU -- S16
zigBee Channel
Minimum 11
  
```

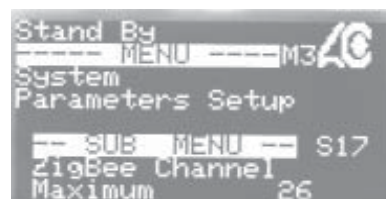

```

Stand By
----- MENU -----M3
System
Parameters Setup

-- SUB MENU -- S17
zigBee Channel
Maximum 26
  
```

Scroll down button

- *Istruzioni per settare la comunicazione Zig-Bee (wireless)*

Settare l'indirizzo di rete della macchina
(min 100)
(max 110).

Inserire la chiave di comunicazione Zig-Bee (ETRX2 USB) nella porta usb del computer e lanciare il programma di visualizzazione.

Installare il programma SMART SYSTEM MONITOR (fornito dalla ditta Cattani S.p.A.) sul computer.

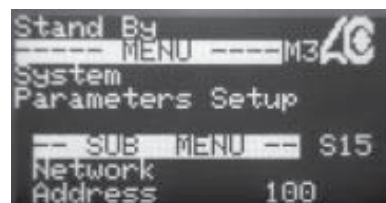

Una volta lanciato il programma comparirà per 10 secondi l'immagine aziendale dopodichè entrerà nel menù principale.



Cliccare sul menù SERVICE così da poter entrare nella pagina della ricerca dei dispositivi.



Cliccare sulla ricerca dei dispositivi disponibili, il programma inizierà la ricerca e l'operazione potrà richiedere alcuni secondi, al termine si potranno visualizzare le varie macchine disponibili ed il loro relativo codice generato, potrebbe essere necessario ripetere l'operazione più volte.

Dopo che il programma avrà trovato i dispositivi disponibili si dovrà ritornare ad home page per poter visualizzare i parametri.

Tramite il menù a tendina si deve scegliere quale Micro-Smart si vuole visualizzare.

A questo punto sarà possibile visualizzare i parametri funzionali.

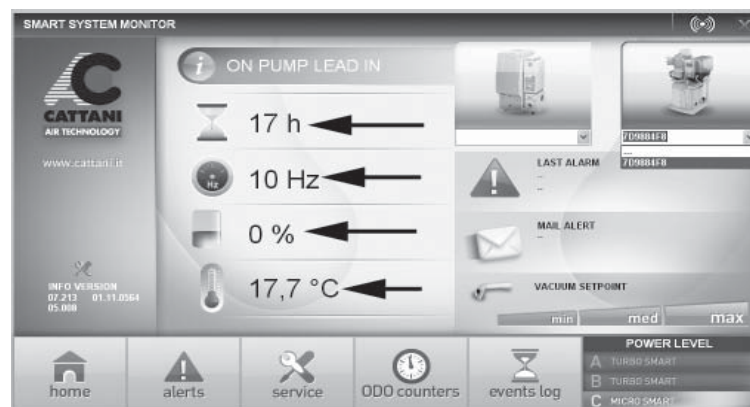
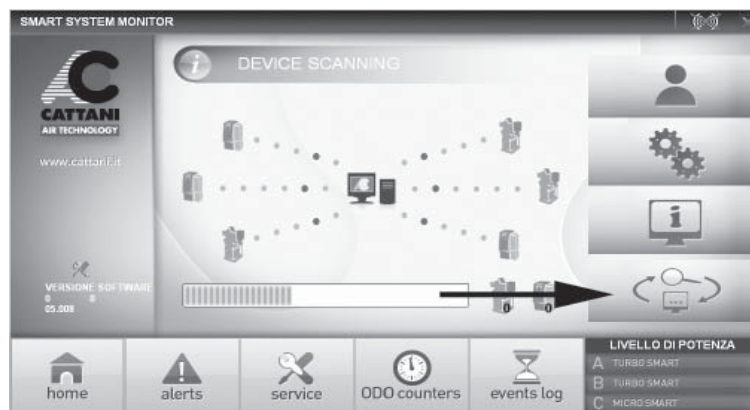

Cliccando sull'icona SERVICE si potrà accedere a tre diversi menù, uno libero e 2 protetti da password.

Per entrare nel menù PARAMETRI UTENTE si deve digitare la password 123000 e premere ok.

In questo menù è possibile cambiare la lingua e impostare il livello di pressione desiderato.

Per entrare nel menù IMPOSTAZIONI DATI DI SISTEMA si deve digitare la password 456000 e premere ok.



In questo menù tecnico sono visibili e modificabili tutti i parametri.

Il menù STATO INVERTER non necessita di nessuna password d'accesso e permette di visualizzare i parametri funzionali della macchina mentre sta funzionando.

Dal menù principale cliccando sull'icona di posta elettronica si potranno inserire i dati, quali: indirizzo del medico e del tecnico che dovrà ricevere le comunicazioni d'allarme.

In caso di anomalia viene visualizzato un allarme nel display e viene inoltre inviata una e-mail al tecnico di riferimento.

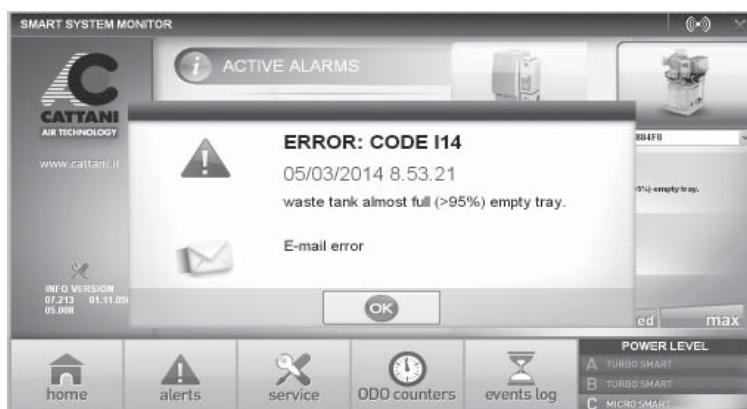
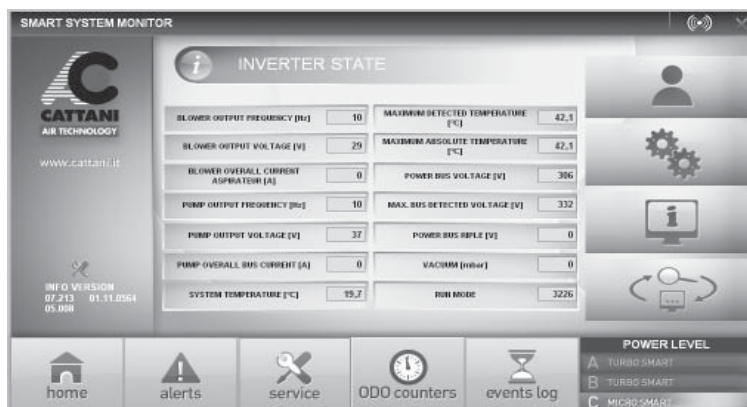

Gli eventuali allarmi avvenuti durante la giornata, sono visualizzati con un codice di errore e la sua descrizione è visibile all'interno della casella ALERTS.

Nella cartella EVENT LOG si potrà visualizzare tutto lo storico degli allarmi accorsi alla macchina durante tutto il periodo di funzionamento.

Nel menù ODO COUNTERS vengono memorizzati i cicli di attivazione.

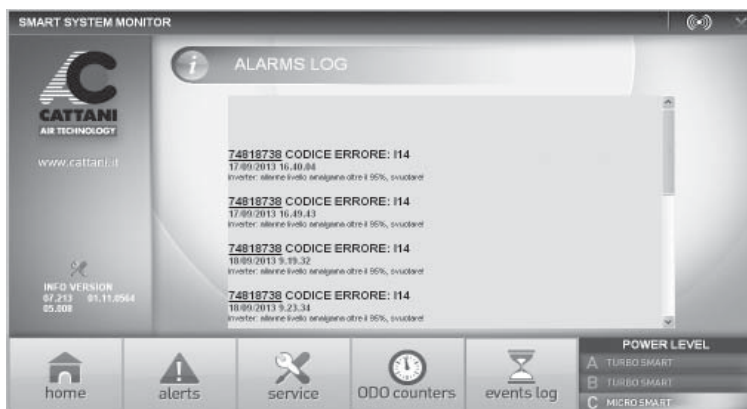
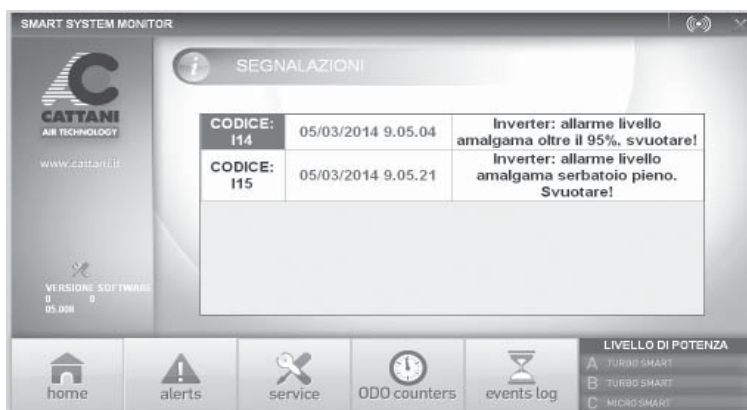

- *Descrizione allarmi*

Codice allarme AC 100	DESCRIZIONE	SOLUZIONE
0	Allarme memoria microcontrollore	Contattare il tecnico
32	Allarme memoria microcontrollore	Contattare il tecnico
33	Cortocircuito dovuto ad uno dei due motori	Verificare da dove proviene il cortocircuito ed eliminarlo
34	Cortocircuito prima del comando motori	Contattare il tecnico (probabile scheda danneggiata)
35	Mancata carica condensatori	Contattare il tecnico (sostituire la scheda)
36	Superata soglia di temperatura	Areare il locale macchine
37	Superata soglia di corrente soffiante	Verificare il funzionamento della soffiante (blocco o resistenza eccessiva)
39	Superata massima tensione sui condensatori	Verificare la tensione di rete max. 260V
40	Cortocircuito centrifuga	Rimuovere il cortocircuito
41	Cortocircuito della scheda nell'uscita centrifuga	Sostituire la scheda
42	Superata soglia di corrente centrifuga istantanea	Eliminare i sifoni nella tubazione o verificare il funzionamento della centrifuga (blocco o resistenza eccessiva)
43	Superata soglia di corrente centrifuga ritardata	Eliminare i sifoni nella tubazione o verificare il funzionamento della centrifuga (blocco o resistenza eccessiva)
45	Lettore amalgama scollegato	Collegare il sensore amalgama
46	Superato il 95% livello amalgama	Sostituire il contenitore amalgama appena possibile
47	Superato il 100% livello amalgama	Sostituire il contenitore amalgama
48	Tubo sensore di vuoto scollegato	Collegare il tubo del vuoto con la centrifuga
49	Pastiglia termica scattata	Ripristinare la temperatura della sala macchine

- *Avvisi importanti*
- *Trasporto e stoccaggio*
- *Trasporto di apparecchi usati*

• *Avvisi importanti*

- Gli apparecchi sono in garanzia per un anno* dalla data di vendita, a condizione che si ritorni alla casa costruttrice il talloncino di garanzia con indicato: data di vendita, venditore e cliente utilizzatore.
- La garanzia e la responsabilità del fabbricante decadono quando gli apparecchi vengono trattati con prodotti non idonei o diversi da quelli indicati dal costruttore, utilizzati in modo scorretto, e quando vengono manomessi con interventi di qualsiasi natura da persone non autorizzate dal fabbricante.
- La casa costruttrice, i concessionari, gli agenti ed i tecnici autorizzati, sono a disposizione per consigli, indicazioni, e per fornire documentazione, pezzi di ricambio, e quant'altro possa essere utile.
- Esigenze tecniche, miglioramento dei prodotti, problemi normativi e funzionali, difficoltà di reperibilità dei prodotti o dei semilavorati, possono indurre la casa costruttrice ad apportare modifiche che alla produzione senza preavviso.
- Nel sito internet www.cattani.it sono rintracciabili i nostri manuali aggiornati. Ne consigliamo la consultazione specialmente per gli aggiornamenti sulla sicurezza.
- Micro-Smart è una apparecchiatura AEE, perciò soggetta alla normativa RAEE (Rifiuti di Apparecchiature Elettriche ed Elettroniche).

• *Trasporto e stoccaggio*

- Nel trasporto e nello stoccaggio le attrezzature imballate potranno essere sottoposte alle temperature di -10 °C e + 60 °C.
- I colli non potranno essere esposti all'acqua ed agli spruzzi e non potranno sopportare umidità superiore al 70%.
- I colli sono sovrapponibili solo in terza fila con il medesimo peso.

• *Trasporto di apparecchi usati*

- Prima di imballare, si consiglia di detergere e disinfettare esternamente ed internamente l'aspiratore con Fast&Steril 3 (vedi i capitoli "Segnali ed avvisi" e "Manutenzione ordinaria").
- Vuotare tutti i tubi e le comunicazioni esterno/interno, eventuali residui di liquido (anche disinfettante) potrebbero danneggiare il centralino. Togliere il vaso di raccolta amalgama, aggiungere il disinfettante, chiudere il vaso con il coperchio a tenuta. Ad aspiratore asciugato esternamente ed internamente, chiudere tutte le comunicazioni esterno/interno con gli appositi tappi, montare un vasetto raccolta amalgama nuovo, avvolgere separatamente apparecchio e il centralino, in modo da impermeabilizzarli al massimo.
- Chiudere l'apparecchio in un sacco di polietilene ed imballare in cartone a tre onde.

(* Per l'estensione della garanzia da 12 a 24 mesi vedere il listino prezzi



MICRO SMART

SUSTAINABLE PROGRESS

INDEX

General running data of the Micro-Smart dental aspirator	26
Introduction	27
Signals and warnings	27
Installation and initial operation	28
Routine maintenance	31
Extraordinary maintenance	32
Instructions to navigate Micro-Smart menus and to modify some parameters	33
Instructions for Zig-bee communication settings (wireless).....	42
Description of alarms.....	47
Important notices.....	48
Transport and storage	48
Transport of second-hand appliances	48
Drawings.....	121

- *General running data of the Micro-Smart dental aspirator*

Model	Micro-Smart
Rated voltage	230 V ~
Rated frequency	50/60 Hz
Rated current	6,3 A
Protection against electric shock	Class I
Operating conditions	Continuous operation
Protection against ingress of liquids	Ordinary
Degree of protection against electric shock	Type B
Max. absorbed power	1,30 kW
Max. flow	55 m ³ /h
Max. head for continuous service	2100 mm H ₂ O
Sound pressure (version without box) from 60Hz to 120Hz	from 64 dB(A) to 71 dB(A)
Aspirating unit sound pressure (version with plastic box) from 60Hz to 120Hz	from 63 dB(A) to 68,5 dB(A)
Sound pressure (version with indoor box) from 60Hz to 120Hz	from 41 dB(A) to 48 dB(A)
Sound pressure (version with outdoor box) from 60Hz to 120Hz	from 54,5 dB(A) to 61,2 dB(A)

~	Alternating current	IEC 417-5032
⊕	Earthing	IEC 417-5019
⚡	Degree of protection against electric shock	CEI EN 60601-1
○	Open (disconnected from the main electrical supply)	IEC 417-5008
I	Closed (connected to the main electrical supply)	IEC 417-5007

Sound pressure level tested according to the standard ISO 3746-1979 (E).
Parameters: r = 1,5 – background noise: 34 dB (A) – instrument Bruel & Kjaer type 2232.

- *Introduction*
- *Signals and warnings*

- **Introduction**

This booklet is intended to illustrate the installation and initial operation of the appliance. It also informs on possible dangers and the precautions that should be taken in order to avoid accidents.

This manual should be always available for consultation during installation, initial operation, use and maintenance operations of Micro-Smart.

Our updated manuals are available at www.cattani.it.

We recommend their consultation, especially for **updates** concerning **safety**.

- **Signals and warnings**

- *Electrical shock risk: also 230 V \sim can be lethal.* 

- *Biological danger, risk of infections from epidemic diseases.* 

- *General danger sign.* 

- *Personal protections for heavy works.* 

- *Personal protections against biological danger.* 

- *High temperature.* 

- *Keep the room free from flammable, corrosive or explosive material.* 

- *Compulsory direction of flow or of rotation.* 

Warning signs cannot always fully express danger warnings, therefore it is necessary that the user reads the warnings and keeps them in due consideration.

Failure to observe a danger sign or warning may harm operators or patients.

Safety devices must not be removed. Appliances or their functioning must never be modified.

Despite all of our best efforts, it is still possible that danger warnings are not complete: we apologise to the users and kindly request that you pay strict attention to all possible sources of danger that may have passed unnoticed, and to inform us of any that have done so.

• Installation and initial operation

• Recommended precautions

Before unpacking the appliance, check the warning shock-watch on the carton. In the case of it being red or the carton being damaged, accept the material while reserving the right to examine the machine.

Unpack the appliance following the instructions shown on the package. The carton is recyclable. Dispose of it in compliance with regulations in force. Retain the plastic caps that cover all inlets and outlets of the unit, as they must be used if the machine needs to be moved or transported.

The machine installation must be carried out by a specialist, equipped with the necessary tools. Install the appliance in a clean location, far from heat sources, humidity and dust. Micro-Smart can be installed outdoors (on a balcony, in veranda or gardens), provided that it is sheltered from rain, humidity, frost and direct sunshine.

For outdoor installation we recommend the use of our special designed box fitted with double isolating roof, anti-freeze and ventilation systems (both fitted with fixed thermostat for automatic temperature control).

In the plant room temperature can range from a minimum of + 5 °C to +35 °C max.

Micro-Smart fitted with box, for indoors or outdoors installation, can be supplied with antifreeze device. In the case of the plant room requiring ventilation or air-conditioning, we suggest that you contact a thermo-technician for a tailored solution. The plant room must be closed to patients and extraneous people. If such a room is not available, machines must be protected by a suitable cover, which must not be easy to remove. Use protections and danger warning boards to prevent accidental risk from electrical shocks, and/or the possibility (unlikely but not excludible) of fire, explosion and contaminating air or liquid leakage. Only use boxes and covers, be them for indoors or outdoors, that are designed and produced by the manufacturer.

Keep the plant room free from flammable material. Make sure that there is no possibility for gas leakages. Do not connect damaged appliances to the mains power supply. Do not use extension leads, multiple plugs or sockets. Before connecting the machine to the mains, ascertain that the feeding line is complying with the regulations C.E.I. 64-8 and that a thermal switch and a residual current operated circuit-breaker (class A or B) (16A) according to the regulations EN 61008-1 are installed. Light coloured, wooden, linoleum, rubber or marble floors can change colour or be marked if they are kept in contact with rubber vibration-proof devices (1). Therefore, it is necessary to use a rubber sheet or some other suitable material to isolate vibration-proof devices from the floor.

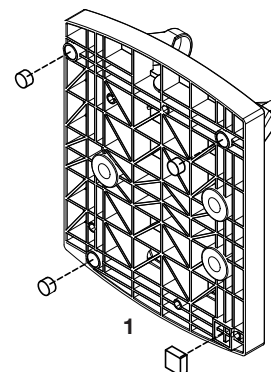
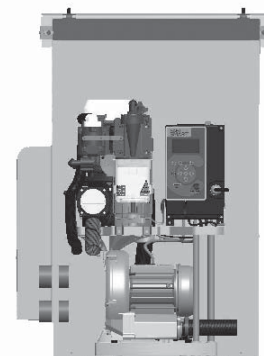
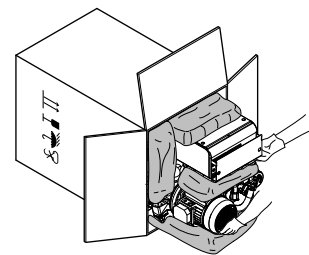

• Installation

Before connecting the aspirator to the piping of the centralized system, ascertain that aspiration piping is clean, as heavy debris can damage the appliance.

Connect the PVC light grey aspiration tube **(3)** (supplied with the machine) to the 30 mm Ø tube-holder **(2)** ("aspirated fluid inlet"). The other end of the same tube should be connected to the aspiration piping **(2b)** coming from the surgeries.

The black heat resistant exhaust air pipe **(4b)**, fitted with a metal spiral, must be connected to the 30 mm Ø tube-holder **(4)** ("exhaust air outlet"). Connect the other end of the pipe to the antibacterial filter **(5)**, passing preferably through a silencer **(5a)** supplied with the aspirator. The hot air coming from the antibacterial filter must be conveyed outside.

Connect the 18 mm Ø tube-holder **(6, page 31)** to the liquid drain pipe. In the version fitted with Hydrocyclone the aspirator is draining liquids by gravity and therefore fluids cannot be pumped upwards at all, and the pipe must be at the same level as, or lower than, the waste fluid outlet. The 10 mm Ø tube-holder **(8, page 30)** ("emergency drain") must be connected to the liquid drain pipe. In the version without Hydrocyclone the 11 mm Ø tube-holder **(6b)** must be connected to the liquid drain pipe. The piping connecting the machine to the aspiration and draining system should be flexible to dampen the small vibrations produced by the aspirator.

The aspiration piping should be run in the floor and at a point near the aspirator it should rise about 30 cm to reach the tube-holder **(2)** (draw. A and B, page 121).

If Micro-Smart is installed at a level lower than the surgeries, the aspiration piping must not enter the centrifugal separator perpendicularly. Rather, place a few metres of piping horizontally on the same level of the machine and then connect it to the centrifugal separator inlet which is at a higher level (using a flexible pipe) (draw.B, page 121).

After the installation is completed, connect the power cable to the mains power supply according to the regulation EN 61008-1.

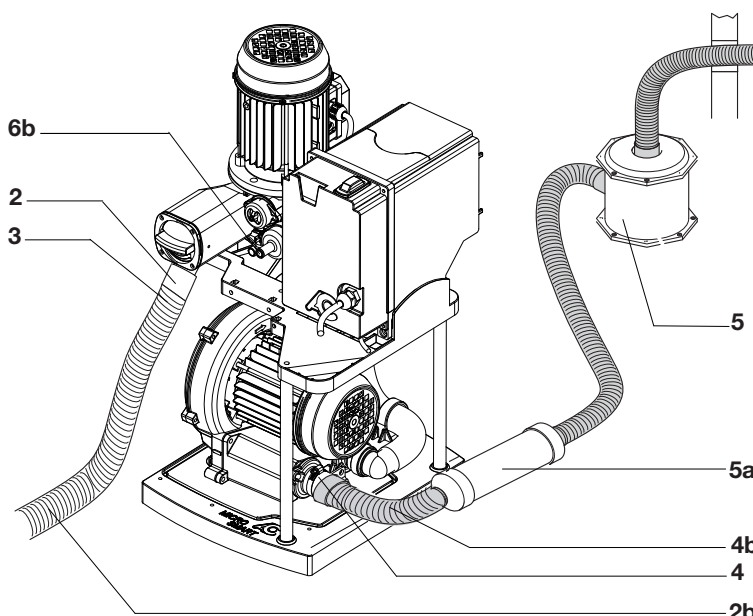
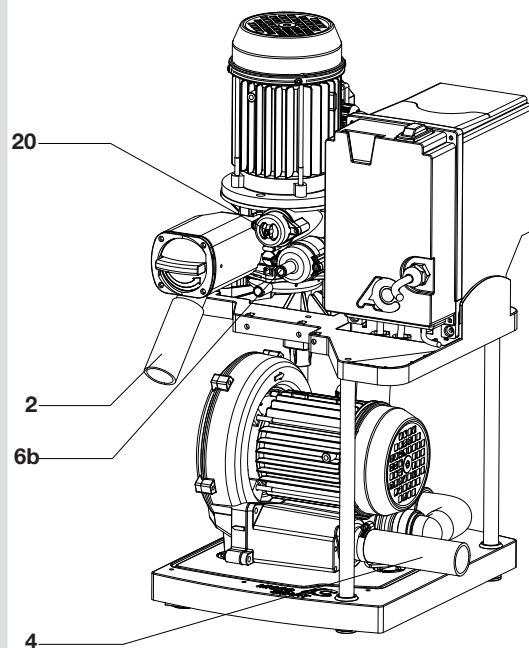

Finally, connect the low voltage line which connects the dental unit to the aspirator. Ascertain that the contacts on the dental unit are clean (volt-free contacts).

- **Starting, final testing and users instructions**

Install and connect the aspirator. Select the ON position on the switch, which is illuminated once one of the dental units has started working. At this point aspiration will start.

To check if Micro-Smart is working correctly, it is advisable to carry out the dynamic tests (see draw. E, page 124) and to consult the Micro-Smart working diagram (draw. F, page 125).

Users must be instructed on the use and routine maintenance of the new, not used, and therefore not yet contaminated, machines.

Demonstrate to users how to follow the Micro-Smart working phases on the display, to interpret danger warnings and to carry out routine maintenance using Puli-Jet plus new (A) - (by means of Pulse-Cleaner) (B) - and Antifoaming Tablets (C) regularly.

- **Operation**

The aspirating unit (9) (through pipe 10) creates vacuum inside the centrifugal separator (11). The fluid coming from the dental units enters the centrifugal separator (11) from the pipe (2).

The centrifugal separator separates air from liquids: air is aspirated through to the suction motor, and then exhausted via the pipe (4), whereas liquids are drained to the sewage through the waste pipe connected to the tube-holder (6) in the version without Hydrocyclone and to the tube-holder (6b) in the version with Hydrocyclone.

The centrifugal separator (11) starts before the aspirating unit (9), this allows drainage of liquids that may have collected inside the centrifugal separator before aspiration starts. Moreover, when the machine is switched off, a timer (adjustable) keeps the motor running for min.10" - max. 120".

- **Amalgam Separator complying to the standard ISO 11143**

On request, Micro-Smart can be supplied with the amalgam separator "Hydrocyclone ISO 5,5 l/min." having its own separate manual.

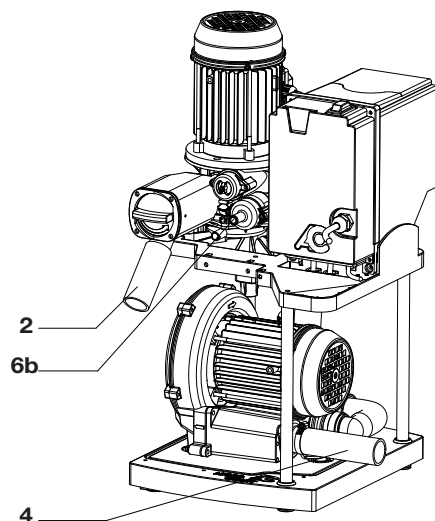
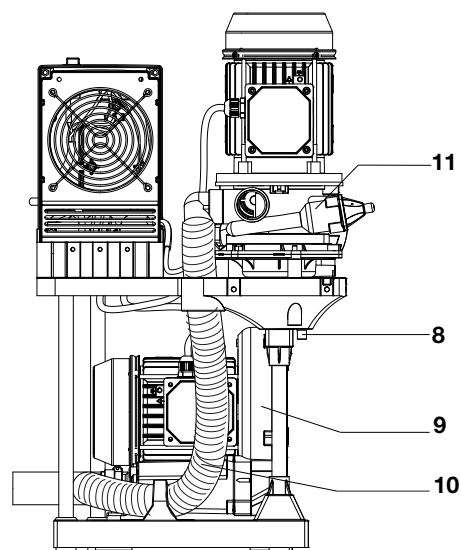
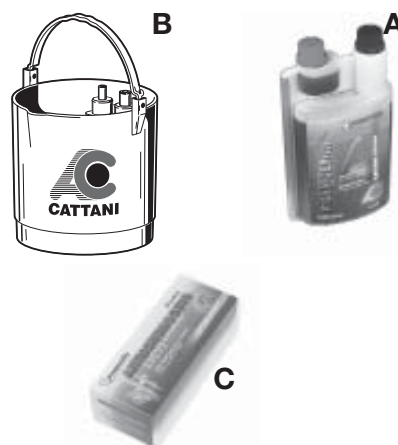

• Routine maintenance

Routine maintenance must be entrusted to specially instructed surgery staff.

- We recommend that special attention be paid to all danger signals, and that protective goggles, gloves and disposable overalls for personal protection be used.

Daily (especially at the end of the working day and/or several times a day according to need)

- Check for any possible alarm on the display. In case of alarms, contact the technician.
- At the end of every working day aspirate a solution of Pu-li-Jet plus new with anti-scale agent **(A)** disinfectant using the Pulse Cleaner **(B)**.
- Clean the aspiration filters on the dental unit, collect the waste, especially amalgam, according to the regulations in force and place the Disinfectant Antifoam Tablets **(C)** in the dental unit filters.
- **Disconnect the machine from the mains before any maintenance intervention.**
- Clean the aspirator's filter.

Periodically, according to need

- Make sure that the aspirator ventilation is not obstructed.
- Keep the plant room free from anything not related to the machines, especially from flammable material. Make sure that there is no possibility for the formation of corrosive, flammable and explosive mixtures.



ALLARME:
TEMPERATURA ELEVATA

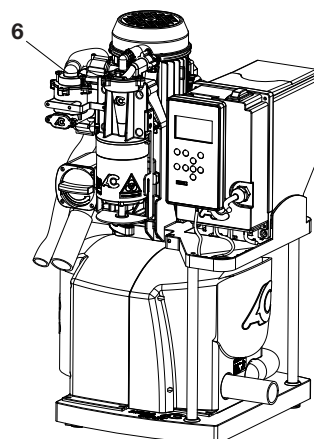
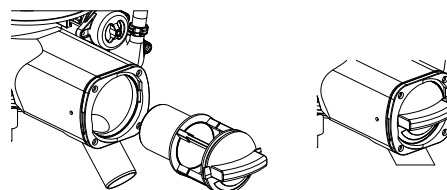
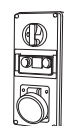
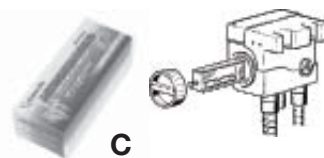
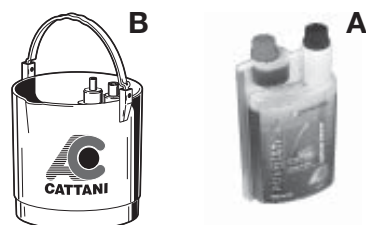

• *Extraordinary maintenance*

Extraordinary maintenance must be entrusted to a trained technician in possession of original spare parts.

- Pay special attention to danger signals. Use protective goggles, gloves and disposable overalls for personal protection.
- Check that routine maintenance has been duly carried out and make sure that Magnolia products are used.
- Before any intervention carry out a series of washes with Fast&Steril 3 (D) disinfectant, then wait 15 minutes for a complete disinfectant action.

Recommended every 12 months *

- Check maximum detected temperatures and all alarms. Intervene accordingly.
- Where routine maintenance is not carried out properly or unsuitable products are used, train the staff and inform the person in charge. Warranty ceases in case appliances are treated with products which are different from those recommended.
- Check the aspirator noise level (see page 26).
- Remove dust from the control panel's fan and heat sink using a blast of dry air not exceeding 2 bar pressure. By means of a 6 bar blast of air clean also the small holes on the frontal cover of the aspirating unit (15).

Recommended every 18-24 months

- Check the conditions of plastic hoses, in particular the hoses under pressure connecting the centrifugal separator (11) and the Hydrocyclone ISO. We suggest to replace these hoses every 18-24 months.
- Check the working conditions of the centrifugal separator (11) and re-circulation valve (14).

Recommended every 10,000/15,000 working hours

- Every time a component containing a rubber part ("O" ring, gasket or seal) is disassembled, replace the rubber part.
- Replace the motors bearings.

(*) Suggested maintenance intervention frequency is approximate. In case of works causing a lot of dust or particularly intensive, increase the frequency of interventions according to the needs.

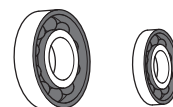
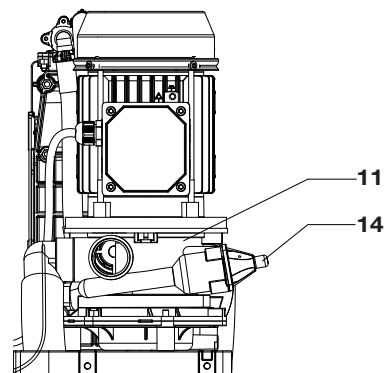
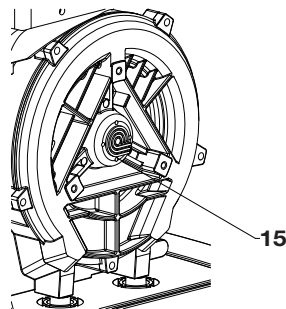
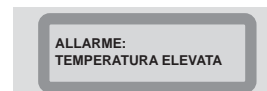

- *Instructions to navigate Micro-Smart menus and to modify some parameters*

Main menus

When Micro-Smart is switched on, the display shows the Cattani logo for 10 seconds, after which time the main menu appears.



Main Menu "A1"

This menu shows some parameters such as: suction motor speed, suction activation time, temperature, presence/absence of the amalgam container and system software release.



Pressing the key  takes you through

Control Menu "A2"

The display shows the number of times Micro-Smart has been switched on by means of the main switch (Power Cycles), the total hours Micro-Smart has had power supplied (Uptime), the number of times suction has been activated (Work Cycles), the total running hours of the aspirator (Work Time), the working hours as regards to the cycles (HZ) used and the number of times the control panel cooling fan has been activated (Fan Cycles).

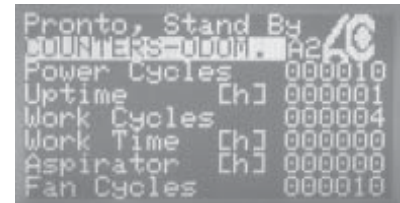

Right arrow 

Events Menu "A3"

This menu shows the last events or alarms that have occurred to Micro-Smart. Events are indicated with a number; refer to the table at page 47 to identify them.

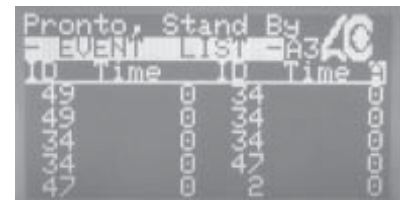

Control Menu "A2"

COUNTERS – ODOM . A2		
POWER CYCLES	000000	Number of times the aspirator has been switched on by means of the main switch.
UPTIME [h]	000000	Total hours Micro-Smart has had power supplied (motors switched-off).
WORK CYCLES	000000	Number of times the aspirator has been activated by the dental unit.
WORK TIME [h]	000000	Number of real running hours (motors running).
ASPIRATOR [h]	000000	Working hours as regards to the cycles (HZ) used.
FAN CYCLES	000000	Number of times the control panel cooling fan has been activated.

Secondary Menu

Press  to enter the Secondary Menu.

Pressing the key  takes you through the other menus.

Drive Status

This menu can be accessed without any access password. The display shows useful information about functioning.

User Parameters

Use the password 0000123000 to enter this menu.

From this menu the Vacuum Set Point and the unit's displayed Language can be set.

System Parameters Setup

The password 0000456000 must be entered to gain access to this menu. From this menu Off Delay Time and other technical parameters can be set.

Factory Settings Restricted Access

This menu cannot be accessed by the user. It can be entered by the manufacturer only.

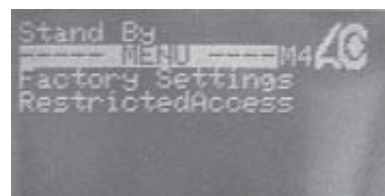
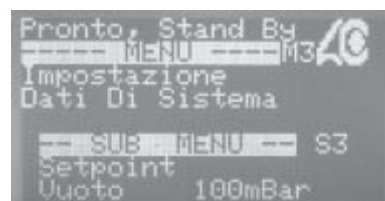
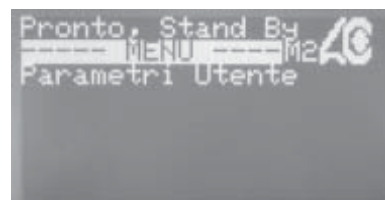
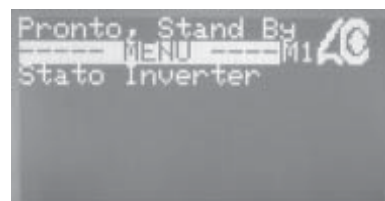
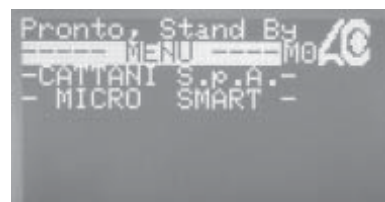
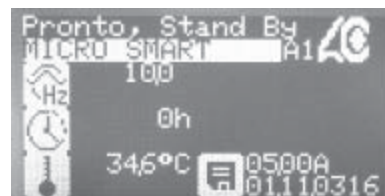

scroll down button
↓



Entering Access Passwords

The Drive Status menu is the only menu that can be accessed without the use of an access password.

To enter the User Parameters and System Parameters Setup menus, you must first enter an access password:

Access password for the User Parameters menu:
0000123000.

Access password for the System Parameters Setup menu:
0000456000.



From the CATTANI S.p.A. menu, press  and then .

The Access Password screen Access Password 0000000000 should then be displayed.



Press the  Enter Key which will make a cursor appear on the last zero to the right.

Press  until the cursor is flashing on the 6th zero.

Press  until number 1 appears.

Press  to move to the next zero and then press .

until number 2 appears.

Press  to move to the next zero and then  press until number 3 appears.

Press the  Enter Key to confirm the password. The cursor will disappear.

Press  to return to the Cattani S.p.A. menu.

It is now possible to modify the parameters of the User Parameters menu.

Repeat the same process to enter the password 0000456000 to gain access to the System Parameters Setup menu.

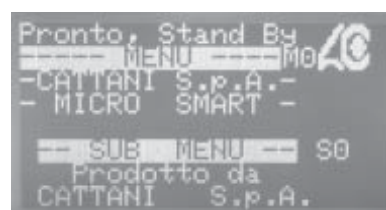
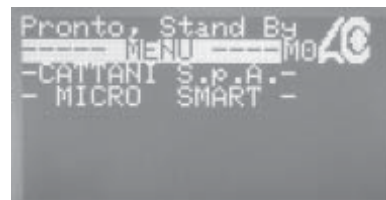

Drive Status Menu

This menu can be accessed without any access password. It displays various technical parameters regarding the real-time working conditions of Micro-Smart. Listed below is the more commonly required information.

Blower Output Frequency (max. setting: 120 Hz)

Blower Output Voltage (max. setting: 220V)

Blower Overall Current (max. setting: 4,3 A)

Pump (Centrifuge) Output Frequency (fixed setting: 75 Hz)

Pump (Centrifuge) Output Voltage (max. setting: 220V)

Pump (Centrifuge) Overall Bus Current (max. setting: 3,2 A)

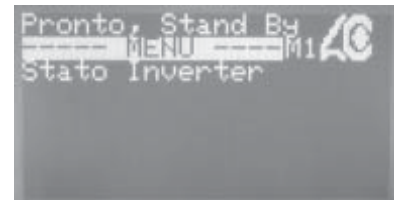

```
Pronto, Stand By
----- MENU ----- M1
Stato Inverter
```

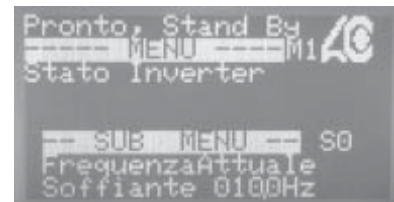

```
Pronto, Stand By
----- MENU ----- M1
Stato Inverter

-- SUB MENU -- S0
FrequenzaAttuale
Soffiante 0100Hz
```

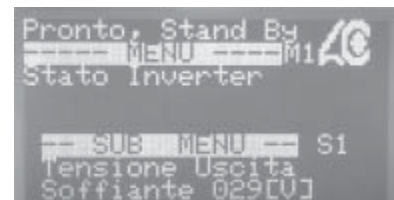

```
Pronto, Stand By
----- MENU ----- M1
Stato Inverter

-- SUB MENU -- S1
Tensione Uscita
Soffiante 029[V]
```

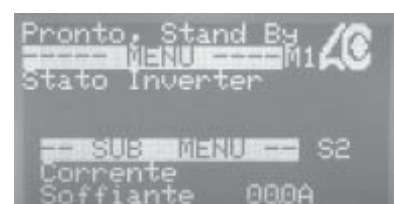

```
Pronto, Stand By
----- MENU ----- M1
Stato Inverter

-- SUB MENU -- S2
Corrente
Soffiante 000A
```

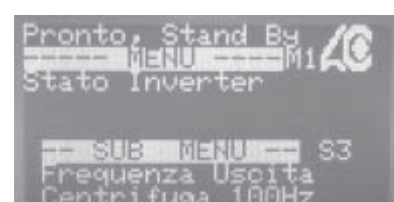

```
Pronto, Stand By
----- MENU ----- M1
Stato Inverter

-- SUB MENU -- S3
Frequenza Uscita
Centrifuga 100Hz
```

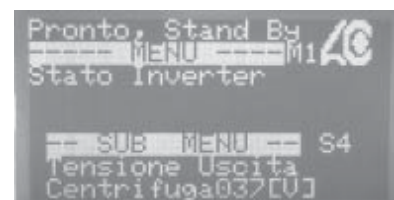

```
Pronto, Stand By
----- MENU ----- M1
Stato Inverter

-- SUB MENU -- S4
Tensione Uscita
Centrifuga037[V]
```

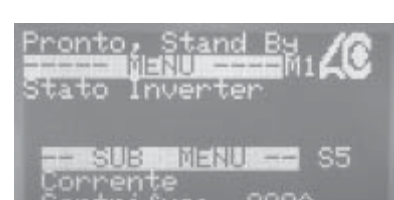

```
Pronto, Stand By
----- MENU ----- M1
Stato Inverter

-- SUB MENU -- S5
Corrente
Centrifuga 000A
```

scroll down button

System Temperature

Maximum Detected Temperature (+60 °C: Alarm and Stop of the aspirator, it can be reset)

Maximum Detected Temperature (+60 °C: Temperature memory, it cannot be reset)

Power Bus Voltage (Max. 390V)

Max. Detected Power Bus Voltage (Max. 390V)

Power Bus Ripple

Vacuum Set Point (max. setting: 210 mbar)

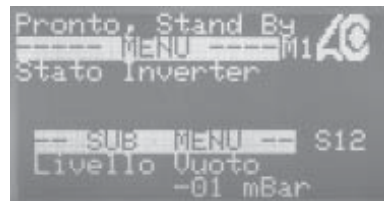
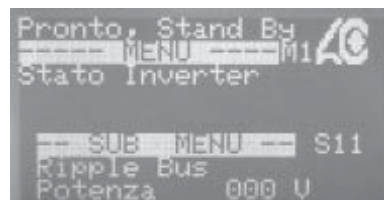
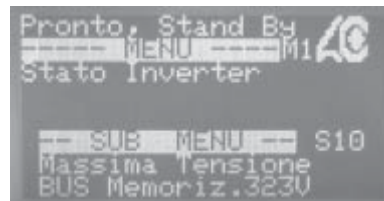
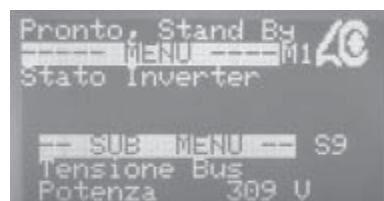
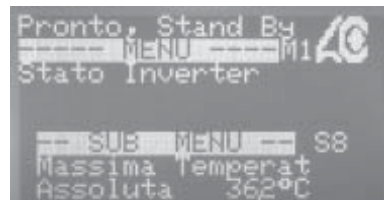
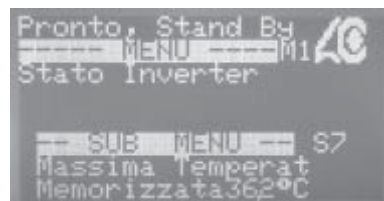
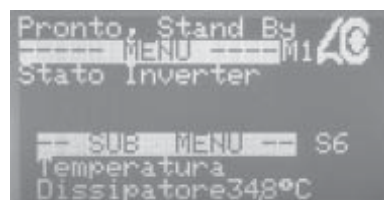

Run mode (it describes the machine's running mode)



User Parameters menu

To access this menu you are required to enter the access password 0000123000 (see instructions on page 35).

Vacuum Set Point

This is the figure to which the unit will limit the vacuum.



Press the  Enter Key to make the cursor appear.

The figure can be changed using the arrow keys  .

Press the  Enter Key again to confirm.

Language

It is possible to choose either English (1) or Italian (0), French (2), German (3) for the displayed language.

Press the  Enter Key to enable the cursor and use the arrow keys   to select 0 or 1 or 2 or 3.

Press the  Enter Key again to confirm the change.

Generated Code

This code is generated by Cattani S.p.A. Each unit is allocated a unique code. At present this code is not used.

Activation Code

At present this code is not used.

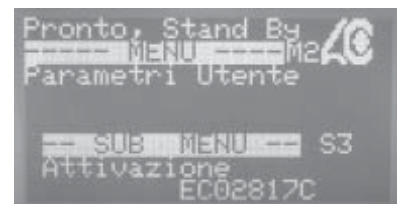
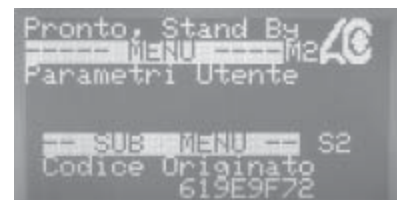
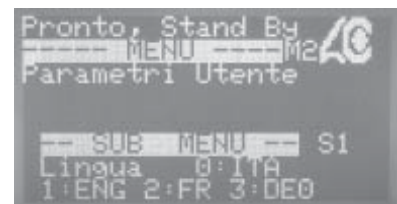
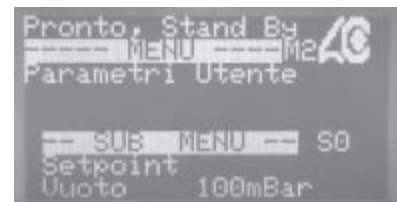
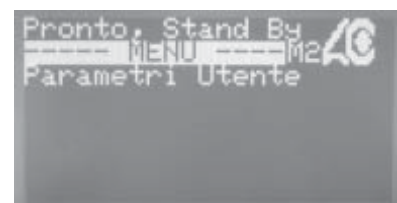
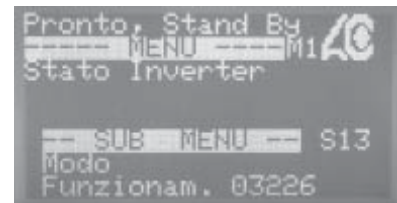



scroll down button

System Parameters Setup menu

To access this menu and/or make any changes, you are required to enter the access password 0000456000 (see instructions on page 35).

To change any parameters in this menu:

Scroll with  through to display the required parameter.

Press the  Enter Key to enable the cursor. The figure can be changed using the arrow keys  .

Once the figure has been set to the desired figure, press the Enter Key  again to confirm and continue.

All the parameters can be regulated.

Min. Vacuum Setting

Max. Blower Output Frequency at the Min. Vacuum Setting

Blower Current limit at the Min. Vacuum Setting

Medium Vacuum Setting

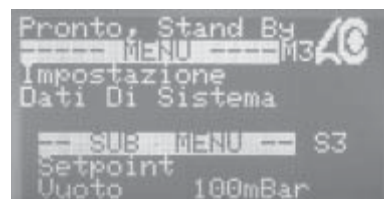
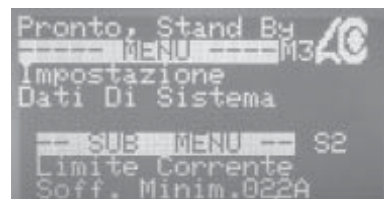
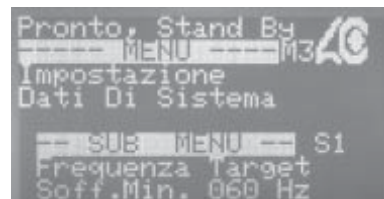
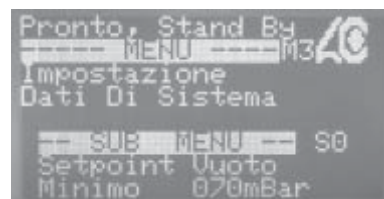

scroll down button

Max. Blower Output Frequency at the Medium Vacuum Setting

Blower Current limit at the Medium Setting

Surgery Vacuum Setting

Max. Blower Output Frequency at the Surgery Vacuum Setting

Blower Current limit at the Surgery Vacuum Setting

Off Delay Time (max. setting: 300")

Pump Off Delay Time (max. setting: 30")

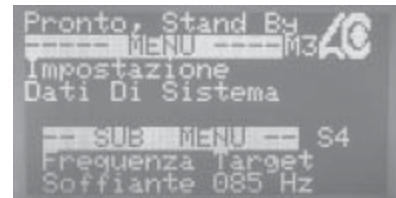

```
Pronto, Stand By
----- MENU ----- M3 AC
Impostazione
Dati Di Sistema

--- SUB MENU --- S4
Frequenza Target
Soffiante 085 Hz
```

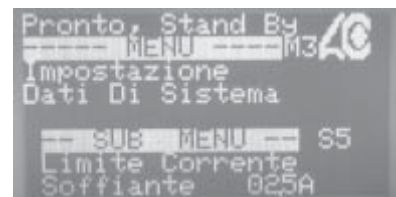

```
Pronto, Stand By
----- MENU ----- M3 AC
Impostazione
Dati Di Sistema

--- SUB MENU --- S5
Limite Corrente
Soffiante 025A
```



```
Pronto, Stand By
----- MENU ----- M3 AC
Impostazione
Dati Di Sistema

--- SUB MENU --- S6
Setpoint Vuoto
Chirurg. 210mBar
```

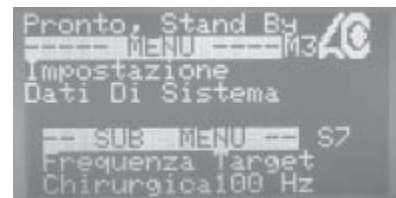

```
Pronto, Stand By
----- MENU ----- M3 AC
Impostazione
Dati Di Sistema

--- SUB MENU --- S7
Frequenza Target
Chirurgica 100 Hz
```



```
Pronto, Stand By
----- MENU ----- M3 AC
Impostazione
Dati Di Sistema

--- SUB MENU --- S8
Limite Corrente
Soff. Chir. 035A
```

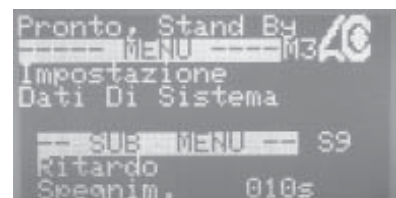

```
Pronto, Stand By
----- MENU ----- M3 AC
Impostazione
Dati Di Sistema

--- SUB MENU --- S9
Ritardo
Spegnim. 010s
```

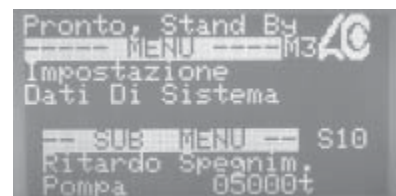

```
Pronto, Stand By
----- MENU ----- M3 AC
Impostazione
Dati Di Sistema

--- SUB MENU --- S10
Ritardo Spegnim.
Pompa 05000t
```

↓ Scroll down button

Blower Off Delay Time (max. setting: 300")

Running Options

This enables or disables the amalgam level sensor.

Set to 0: without amalgam separator

Set to 2: with amalgam separator

Drive Commands

Factory use only.

Modbus address

This menu is not currently used.

Network address

Specify the network address of the Micro SMART for Zig-Bee visualization.

Zig-Bee Minimum Channel

Select the minimum channel on which the Micro SMART shall communicate.

Zig-Bee Maximum Channel

Select the maximum channel on which the Micro SMART shall communicate.

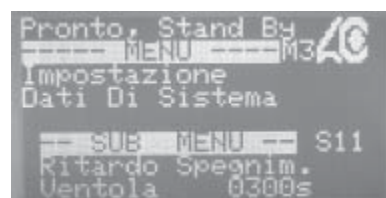

```

Pronto, Stand By
----- MENU ----- M3
Impostazione
Dati Di Sistema

-- SUB MENU -- S11
Ritardo Spegnim.
Ventola 0300s
  
```

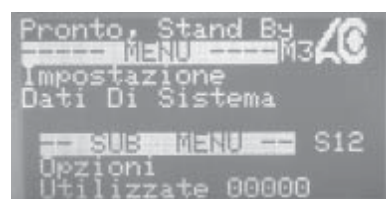

```

Pronto, Stand By
----- MENU ----- M3
Impostazione
Dati Di Sistema

-- SUB MENU -- S12
Opzioni
Utilizzate 00000
  
```

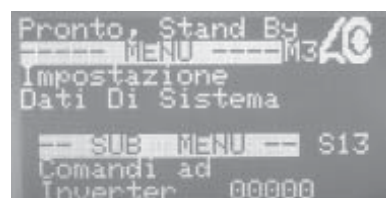

```

Pronto, Stand By
----- MENU ----- M3
Impostazione
Dati Di Sistema

-- SUB MENU -- S13
Comandi ad
Inverter 00000
  
```

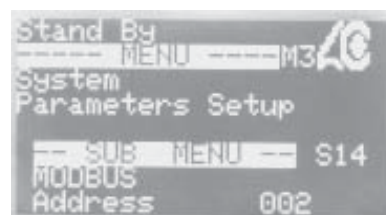

```

Stand By
----- MENU ----- M3
System
Parameters Setup

-- SUB MENU -- S14
MODBUS
Address 002
  
```



```

Stand By
----- MENU ----- M3
System
Parameters Setup

-- SUB MENU -- S15
Network
Address 104
  
```

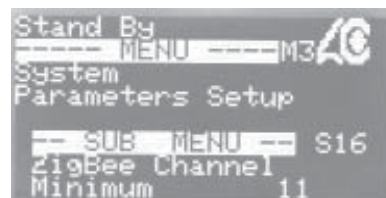

```

Stand By
----- MENU ----- M3
System
Parameters Setup

-- SUB MENU -- S16
zigBee Channel
Minimum 11
  
```

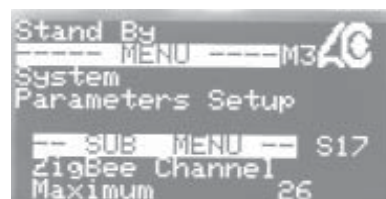

```

Stand By
----- MENU ----- M3
System
Parameters Setup

-- SUB MENU -- S17
zigBee Channel
Maximum 26
  
```

Scroll down button

- *Instructions for Zig-bee communication settings (wireless)*

Set the network address of the machine.
(min. 100)
(max. 110)

Insert the Zig-Bee communication key (ETRX2USB) into a USB connection on the clinic computer and launch the visualization program.

Install the 'Smart System Monitor' program supplied by Cattani Spa.

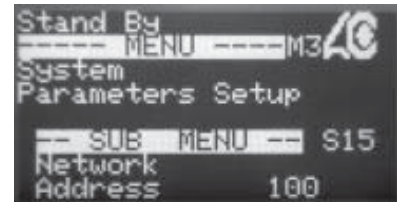

Once the program has been launched the main company screen will be displayed for around 10 seconds, after which time the main menu will appear.



Click on the 'SERVICE' menu in order to enter the device-search page.



Click on the 'search available devices' tab. The program will initiate a search, which can take several seconds. Once the search is completed, the program will display the various available units and their corresponding generated code. NB: It may be necessary to repeat this process several times.

After having found the available devices, return to the home page to view parameters.

Select which Micro SMART you wish to view, by selecting it through the drop-down menu.

It is now possible to view the operating parameters.

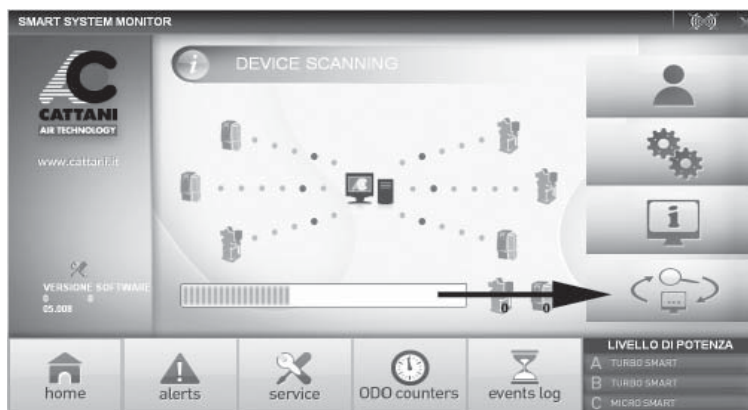

By clicking on the 'SERVICE' tab you can access three different menus, one of which is open, and the other two restricted by a passwords.

To enter the 'USER PARAMETERS' menu enter the password 123000 and press 'OK'.

Through this menu you can select a different language and set the desired vacuum level.

To enter the 'SYSTEM PARAMETERS SETUP' menu enter the password 456000 and press 'OK'.



Through this technical menu you can view and modify all the parameters.

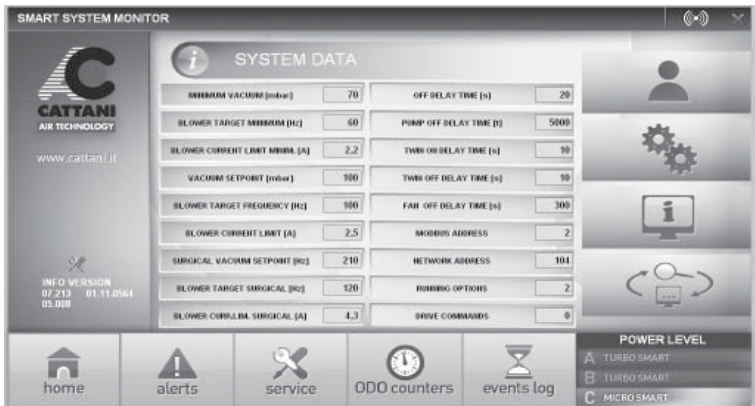

The 'INVERTER STATUS' menu does not require an access password. This menu displays the functional parameters of the machine while it is in operation.



From the main menu, click on the 'E-MAIL' tab to enter the details of the technician or doctor to whom alarm alerts should be sent.



In case of malfunction an alarm will be shown on the screen and an e-mail sent to the contact entered (as per above point).

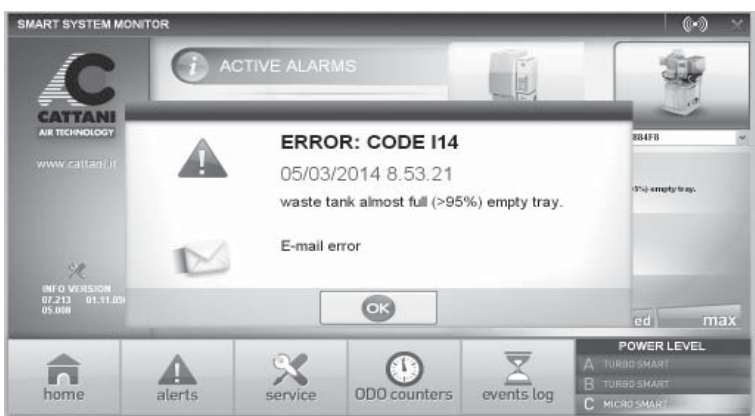

Any alarms generated through the day are displayed with an error code and description in the 'ALERTS' tab.

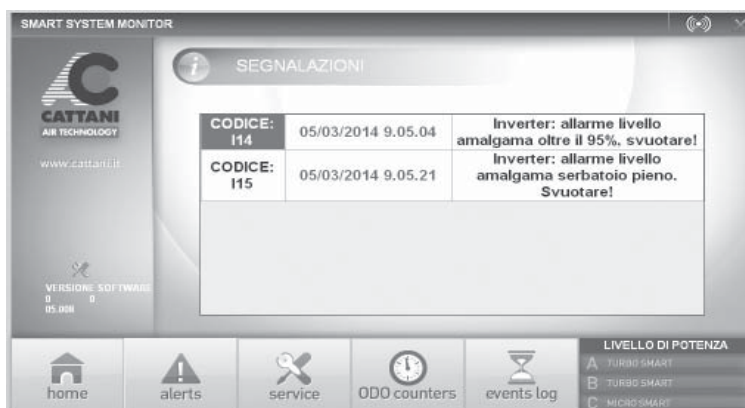

The full history of all alarms registered during the entire period of operation can be viewed through the 'EVENTS LOG' tab.

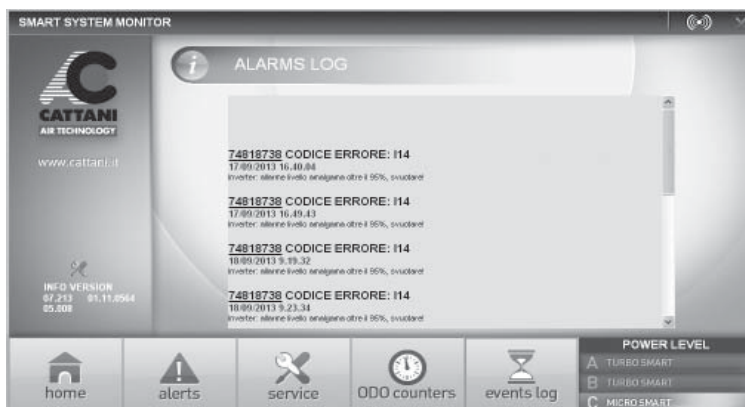

The operation cycles are recorded, and can be viewed by clicking on the "ODO COUNTERS" tab.



• Description of alarms

AC100 Alarm code	DESCRIPTION	SOLUTION
0	Microcontroller memory alarm	Contact the technician
32	Microcontroller memory alarm	Contact the technician
33	Short-circuit in one of the two motors	Identify where the short-circuit is coming from and eliminate it
34	Short-circuit before the motors' starting	Contact the technician (the PC-Board is likely to be damaged)
35	Condensers have not been charged	Contact the technician (replace the PC-Board)
36	Overtemperature (temperature has exceeded the max. allowed limit)	Ventilate the plant room Check operation of the cooling fan
37	Blower overcurrent (the blower has exceeded the current limit)	Check the operation of the blower (seized or excessive friction)
39	Condensers overvoltage (the condensers have exceeded the max.voltage limit)	Check the mains voltage (max. 260V)
40	Centrifuge short-circuit	Eliminate the short-circuit
41	PC-Board short-circuit on the centrifuge output	Replace the PC-Board
42	Centrifuge instant overcurrent (the centrifuge has exceeded the current limit)	Eliminate siphons in the piping or check the centrifuge operation (seized or excessive friction)
43	Centrifuge time delayed overcurrent (the centrifuge has exceeded the current limit)	Eliminate siphons in the piping or check the centrifuge operation (seized or excessive friction)
45	Amalgam level sensor disconnected	Connect the amalgam level sensor
46	Amalgam level > 95%	Replace the amalgam container as soon as possible
47	Amalgam level > 100%	Replace the amalgam container
48	The vacuum detecting tube is disconnected	Connect the vacuum detecting tube to the centrifuge
49	Thermal switch switched-off	Restore the temperature in the machine room

- *Important notices*
- *Transport and storage*
- *Transport of second-hand appliances*

• ***Important notices***

- Appliances are guaranteed for one year from the date of sale, provided that the warranty slip is returned to the manufacturer with date of sale, retailer's and customer's name.
- Warranty and manufacturer's liability cease in case appliances are treated with products which are unsuitable or different from those recommended by the manufacturer and also in case appliances are improperly used or tampered with operations of any kind carried out by people who are not authorized by the manufacturer.
- The manufacturer, concessionaires, agents and authorized technicians are at customers' disposal for advice and assistance and to supply literature, spare parts and anything useful.
- The manufacturer reserves the right to modify the products for improvements, for technical, normative and functional reasons or for problems due to the availability of products or semi-finished products, without prior notice.
- Our updated manuals are available at www.cattani.it. We recommend they are consulted especially for updates concerning safety.
- Micro-Smart is a EEE device, therefore it is subject to the WEEE (Waste of Electrical and Electronic Equipment) regulations.

• ***Transport and storage***

- Packed appliances can be transported and stored at a temperature ranging from -10 °C to +60 °C.
- Packages must be kept away from water and splashing and cannot tolerate humidity >70%.
- Packages with the same weight can be stored in piles of three only.

• ***Transport of second-hand appliances***

- Before packing, we suggest to cleanse and disinfect the aspirator with Fast & Steril 3 (refer to the paragraphs "Signals and warnings" and "Routine maintenance").
- Drain all tubes and ports (including those that convey fluids from inside machine) and possible residual fluids (including disinfectant), which can damage the control panel. Remove the amalgam collection canister, add the disinfectant, place and then lock the hermetically sealed lid on the canister. Once the suction unit is dry –both externally and internally- close all of the inlets and outlets with the purpose-made caps, fit a new (and empty) amalgam collection canister to the unit, and wrap both the suction unit and control panel separately in plastic, in order to ensure that these items are waterproof.
- Place the machine into a polyethylene bag, seal and pack it in 3-layer corrugated board.



MICRO SMART

SUSTAINABLE PROGRESS

FRANÇAIS

INDEX

Données générales de fonctionnement de l'aspirateur pour l'usage dentaire Micro-Smart	50
Introduction	51
Signaux et avertissement	51
Installation et mise en marche	52
Entretien ordinaire	55
Entretien extraordinaire	56
Instructions pour naviguer dans les menus du Micro-Smart et modifier certains paramètres	57
Instruction pour la calibration de la communication sans fil Zig-Bee	66
Description des alarmes	71
Avis importants.....	72
Transport et stockage	72
Transport des appareils usagés	72
Tables	121

- *Données générales de fonctionnement de l'aspirateur pour l'usage dentaire Micro-Smart*

Modèle	Micro-Smart
Tension nominale	230 V ~
Fréquence nominale	50/60 Hz
Courant nominal	6,3 A
Type d'isolation contre les contacts directs et indirects	Classe I
Mode d'emploi	Fonctionnement continu
Protection contre l'humidité	Commune
Degré de protection contre les contacts directs ou indirects	Type B
Puissance absorbée maximum	1,30 kW
Débit maximum	55 m ³ /h
Dépression maximum en service continu	2100 mm H ₂ O
Pression sonore version sans capot de 60 Hz à 120 Hz	de 64 dB(A) à 71 dB(A)
Pression sonore moteur d'aspiration version capotée en plastique de 60 Hz à 120 Hz	de 63 dB(A) à 68,5 dB(A)
Pression sonore version capotée pour installation à l'intérieur de 60 Hz à 120 Hz	de 41 dB(A) à 48 dB(A)
Pression sonore version capotée en métal pour installation à l'extérieur de 60 Hz à 120 Hz	de 54,5 dB(A) à 61,2 dB(A)

~	Courant alternatif	IEC 417-5032
⊕	Conducteur de protection	IEC 417-5019
⚡	Degré de protection contre les contacts directs ou indirects	CEI EN 60601-1
○	Ouvert (déconnecté du réseau d'alimentation)	IEC 417-5008
I	Fermé (connecté au réseau d'alimentation)	IEC 417-5007

Niveau de pression sonore obtenu selon la norme ISO 3746-1979 (E).
Paramètres : r = 1,5 - bruit de fond : 34 dB (A) - Instrument : Brüel & Kjær type 2232.

- *Introduction*
- *Signaux et avertissement*

- **Introduction**

La présentation ci-après a pour objectif d'illustrer l'installation et la mise en marche du Micro-Smart et de renseigner sur les dangers et les précautions à prendre pour une bonne prévention des accidents.

Ce manuel doit être toujours disponible pendant l'installation, la mise en marche, l'utilisation et l'entretien du Micro-Smart.

Sur le site internet www.cattani.it on peut trouver nos manuels techniques **mis à jour**.

Nous recommandons de les consulter surtout pour les mises à jour concernant la **sécurité**.

- **Signaux et avertissement**

- *Danger de décharge électrique - même le courant 230 V \sim peut être mortel.* 

- *Danger biologique d'infection par des maladies épidémiques.* 

- *Signal générique de danger.* 

- *Protections personnelles pour gros travaux.* 

- *Protections personnelles pour danger biologique.* 

- *Haute température.* 

- *Local interdit aux substances inflammables, corrosives ou explosives.* 

- *Direction obligatoire du flux ou du sens de rotation.* 

Il n'est pas toujours possible d'exprimer par un signal les avis de danger, il est donc nécessaire que l'utilisateur lise les avertissements et en tienne compte.

Ne pas respecter un signal ou un avis de danger peut entraîner des dommages aux opérateurs ou aux patients.

Ne pas retirer les protections contre les accidents ; ne pas modifier les appareils ou leur fonctionnement.

En dépit de nos efforts, il est possible que les avis de danger ne soient pas exhaustifs. Nous nous excusons auprès des utilisateurs et les prions en même temps de se protéger contre toute source de danger que nous pouvons avoir négligée et de nous en informer.

• Installation et mise en marche

• Précautions recommandées

Avant d'installer l'appareil, contrôler l'extérieur de l'emballage. Faites attention à l'étiquette shockwatch. Si elle est rouge ou si le carton a été endommagé, acceptez le matériel en vous réservant de contrôler l'appareil.

Déballer la machine selon les instructions dessinées sur l'emballage. Le carton est recyclable. Nous recommandons de l'évacuer selon les normes en vigueur. Conserver tous les bouchons plastique qui ferment les entrées et sorties de l'appareil, car doivent être utilisés pour déplacer ou transporter la machine.

L'installation des machines doit être effectuée par un technicien expert et équipé. Placer l'aspirateur dans un endroit propre, loin des sources de chaleur, de l'humidité et de la poussière. En cas d'installation à l'extérieur (balcon, véranda, jardin) il faut protéger les machines de la pluie, de l'humidité, du gel et des rayons directs du soleil.

Pour l'installation à l'extérieur nous pouvons fournir un capot spécial qui inclut : double toit isolant, protection antigel et système de ventilation avec thermostat fixe pour la régulation automatique de la température.

Dans le local technique, maintenir une température comprise entre + 5°C et + 35°C.

Les machines capotées, pour l'intérieur ou l'extérieur, peuvent être fournies avec équipement antigel. Si votre local technique doit être ventilé ou climatisé, nous vous suggérons de confier le projet à un frigoriste. Le local technique doit être interdit aux patients. Si un local semblable n'est pas disponible, il faut protéger les machines avec des capots qui ne puissent pas être enlevés facilement. Utilisez des protections et des signaux de danger de façon à éviter les contacts accidentels qui sont dangereux à cause des décharges électriques, de la possibilité (très rare mais qui ne peut pas être totalement exclue) d'incendie, d'explosion et de fuite d'air ou de liquides contaminants. Pour l'installation à l'intérieur et à l'extérieur n'employer que des capots spécialement conçus et produits par le fabricant des machines.

Il ne faut pas introduire des substances inflammables dans le local technique. Veiller qu'il n'y ait aucune possibilité de fuites de gaz. Ne pas brancher au courant des appareils endommagés ; n'utiliser ni rallonges ni prises ou fiches multiples. Avant de brancher l'appareil au courant, s'assurer que la ligne d'alimentation est conforme aux normes C.E.I. 64-8 et qu'un interrupteur thermique et un interrupteur à courant différentiel résiduel (classe A ou B) (16A) selon les normes EN 61008-1 sont présents. Les planchers de couleur claire, de bois, linoléum, caoutchouc ou marbre peuvent changer de couleur ou se tacher au contact des pieds antivibration **(1)**. Isoler ces derniers du plancher avec une feuille en plastique ou un autre matériau indiqué.

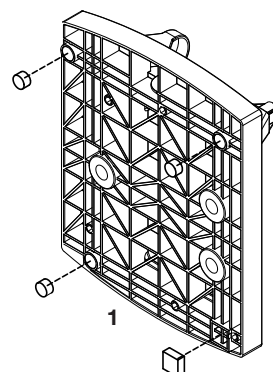
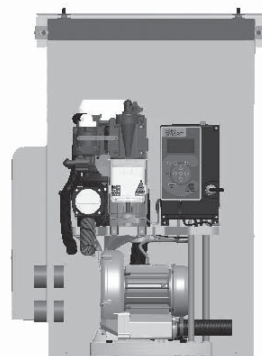
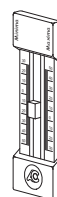
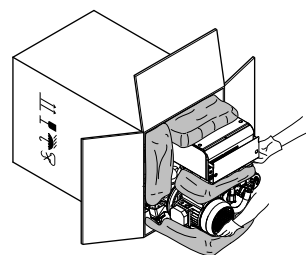

• Installation

Avant de relier l'appareil à la canalisation du système centralisé, s'assurer que les tuyauteries d'aspiration sont propres ; les débris lourds pourraient endommager l'appareil.

Le tuyau en PVC (3) gris clair qui est fourni avec l'appareil doit être relié au porte-tuyau (2) diamètre 30 mm (« entrée fluides aspirés »). L'autre extrémité du tuyau doit être reliée à la canalisation d'aspiration (2b) qui vient des cabinets.

Le tuyau noir pour l'air expulsé (qui contient une spirale métallique et qui est résistant à la chaleur) (4b) doit être relié au porte-tuyau (4) diamètre 30 mm (« sortie air expulsé »). Relier l'autre extrémité du même tuyau au filtre antibactérien (5) après être passé par le silencieux (5a) fourni avec l'aspirateur. A la sortie du filtre antibactérien, l'air expulsé, qui est encore chaud, doit être dirigé à l'extérieur.

Relier le porte-tuyau (6, page 55) diamètre 18 mm au tuyau de vidange des liquides. Le porte-tuyau (8, page 54) diamètre 10 mm (vidange de sécurité) doit être relié à la vidange des liquides. Dans la version avec Hydrocyclone l'aspirateur draine les liquides par gravité, donc la vidange doit être plus basse. Dans la version sans Hydrocyclone le porte-tuyau (6b) diamètre 11 mm doit être relié au tuyau de vidange des liquides. Les tuyaux de jonction entre la machine et le système d'aspiration et de drainage sont flexibles à fin d'amortir les petites vibrations produites par le fonctionnement de l'aspirateur.

En général les tuyaux d'aspiration courent dans le plancher et près de l'aspirateur un tuyau monte d'à peu près 30 cm pour arriver au porte-tuyau (2) (fig. A et B, page 121).

Dans le cas où Micro-Smart est installé à l'étage au-dessous des unités dentaires, le tuyau d'aspiration ne doit pas entrer directement dans le séparateur centrifuge, quelques mètres de tuyau doivent être installés horizontalement au même niveau que la machine jusqu'à l'entrée du séparateur centrifuge (fig. B, page 121) (utiliser un tuyau flexible) qui se trouve sur un niveau plus haut. Les fluides seront reaspirés par la machine.

Après l'installation, il faudra brancher le câble d'alimentation à la ligne électrique du local technique selon la norme EN 61008-1.

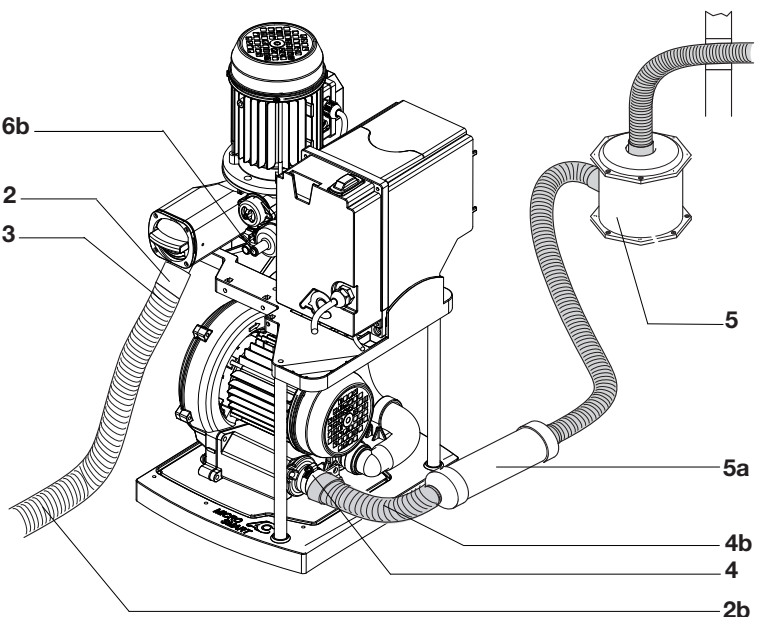
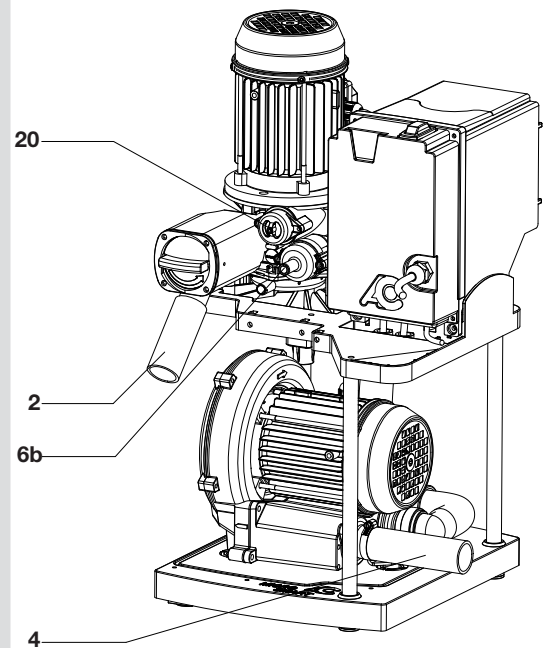

A la fin, brancher la ligne de télécommande des utilisateurs qui relie l'unité dentaire à l'aspirateur. S'assurer que le contact sur l'unité dentaire est sans tension (contact sec).

- **Mise en marche, essai et instruction des utilisateurs.**

Lorsque l'aspirateur a été installé et branché au courant, positionner l'interrupteur sur la position ON, l'interrupteur va s'éclairer et dès qu'un des unités commande l'aspiration elle se met en marche.

Afin de vérifier le fonctionnement correct du Micro-Smart, il est conseillé d'effectuer les tests dynamiques (fig. E, page 124) et de consulter le Diagramme de fonctionnement du Micro-Smart, fig.F, page 125.

Pour l'instruction des utilisateurs sur l'usage et l'entretien ordinaire de l'aspirateur utiliser une machine neuve, non utilisée et donc non contaminée.

Le personnel du cabinet devra être instruit à suivre sur l'écran les phases de fonctionnement du Micro-Smart, à interpréter les avertissements de danger, à effectuer un entretien correct avec le Puli-Jet Plus new (A) en utilisant le Pulse Cleaner (B) et à utiliser les pastilles antimousse (C) régulièrement.

- **Fonctionnement**

Le moteur d'aspiration (9) (à travers le tuyau 10) crée la dépression dans le séparateur centrifuge (11). Les fluides qui viennent des unités dentaires entrent dans le séparateur centrifuge (11) à travers le tuyau collecteur (2).

Le séparateur centrifuge sépare l'air des liquides : l'air est expulsé à l'extérieur à travers le tuyau (4), tandis que les liquides sont évacués dans la vidange à travers le tuyau de vidange relié au porte-tuyau (6) dans la version sans Hydrocyclone et au porte-tuyau (6b) dans la version avec Hydrocyclone.

Le séparateur centrifuge (11) se met en marche avant le moteur d'aspiration (9). Ça permet de drainer les liquides qui peuvent se déposer dans le séparateur centrifuge avant que l'aspiration soit mise en marche. En outre, quand la machine est arrêtée, un temporisateur (réglable) maintient l'aspirateur en marche pour min.10" - max.120".

- **Séparateur d'amalgame selon les normes ISO 11143 : 2008-10**

Micro-Smart peut être fourni avec le séparateur d'amalgame « Hydrocyclone ISO 5,5 l/min. », qui est livré avec son manuel.

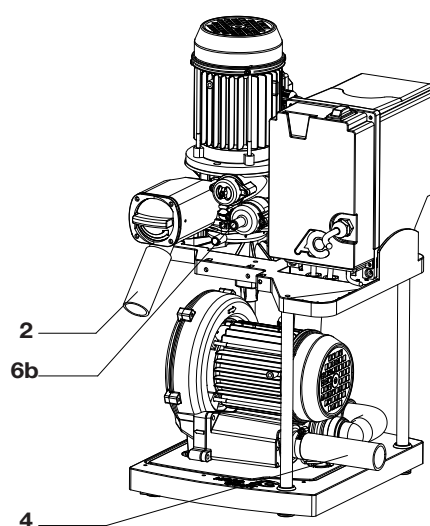
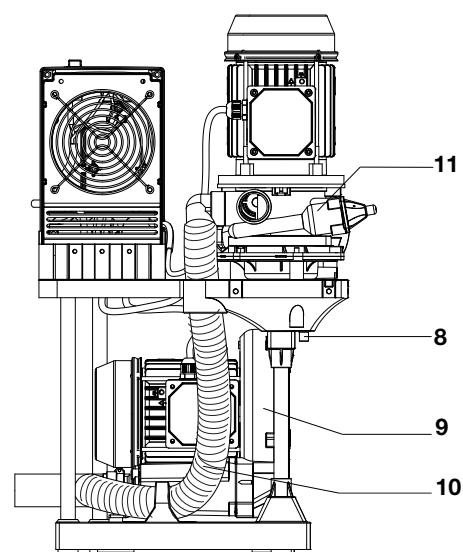
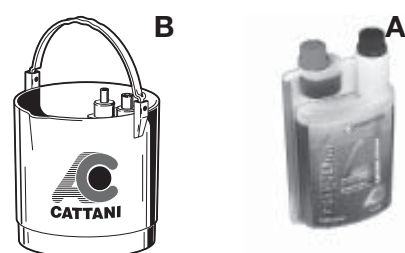

• *Entretien ordinaire*

L'entretien ordinaire doit être confié au personnel du cabinet expressément instruit.

- Nous recommandons de faire attention à tous les signaux de danger et de se protéger avec lunettes, gants et tablier jetables.

Tous les jours, surtout le soir, ou plusieurs fois par jour selon le besoin

- Vérifier sur l'écran la signalisation des alarmes éventuelles, en cas d'avis de danger, contacter le technicien.
- Aspirer le soir la solution de Puli-Jet Plus new désinfectant avec anticalcaire **(A)** en utilisant le Pulse Cleaner **(B)**.
- Nettoyer les filtres des unités dentaires, récupérer les déchets selon les normes en vigueur, surtout l'amalgame, et mettre des pastilles antimousse désinfectantes **(C)** dans les filtres des unités dentaires.
- **Débrancher le courant avant toute intervention sur la machine.**
- Nettoyer le filtre de la machine.

De temps en temps, selon le besoin

- Vérifier qu'il ne se forme pas d'obstacles à la ventilation libre de l'aspirateur.
- Tenir le local technique libre de tout ce qui n'a rien à voir avec les machines, particulièrement des matières inflammables. Veiller qu'il n'y ait aucune possibilité de formation de mélanges corrosifs, inflammables ou explosifs.



ALLARME:
TEMPERATURA ELEVATA

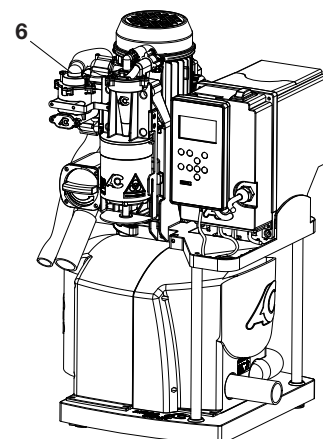
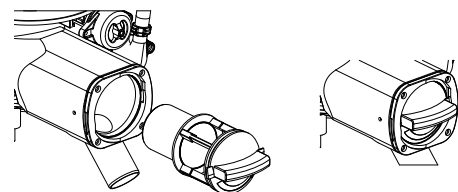
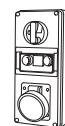
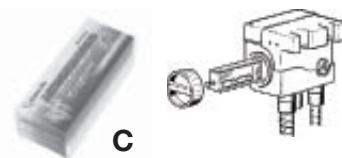
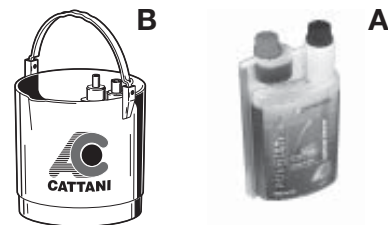

• *Entretien extraordinaire*

L'entretien extraordinaire doit être confié à un technicien formé et autorisé disposant des pièces de rechange d'origine.

- Faire attention à tous les signaux de danger et se protéger avec lunettes, gants et un tablier jetables.
- Contrôler que l'entretien ordinaire ait été exécuté soigneusement et vérifier qu'on utilise les produits Magnolia.
- Avant toute intervention, laver plusieurs fois l'appareil avec Fast&Steril 3 (D). Attendre 15 minutes pour obtenir une action désinfectante complète.

Contrôles conseillés tous les 12 mois *

- Vérifier les températures maximum enregistrées et tous les signaux d'alarme, intervenir selon les exigences du cas.
- Si on constate une précarité d'entretien ou l'utilisation de produits impropres, instruire le personnel et informer le responsable du cabinet. La garantie cesse lorsque les équipements sont traités avec des produits différents de ceux recommandés.
- Contrôler le bruit de l'aspirateur (voir page 50).
- A l'aide d'un jet d'air sec ne dépassant pas 2 bars de pression enlever la poussière sur le ventilateur et le dissipateur de la boîte de commande et avec un jet d'air à 6 bars nettoyer les petits trous sur le couvercle frontal du moteur d'aspiration (15).

Contrôles conseillés tous les 18-24 mois

- Contrôler l'état des tuyaux en plastique, en particulier des tuyaux sous pression de jonction entre le séparateur centrifuge (11) et l'Hydrocyclone ISO. Nous conseillons de remplacer ces tuyaux tous les 18-24 mois.
- Contrôler les conditions de fonctionnement du séparateur centrifuge (11) et de la soupape de recirculation (14).

Contrôles conseillés toutes les 10.000/15.000 heures de fonctionnement

- Lorsqu'un composant contenant une pièce en caoutchouc (joint torique ou joint d'étanchéité) est désassemblé remplacer la pièce en caoutchouc.
- Remplacer les roulements des moteurs.

(*) La fréquence des contrôles est indicative. En présence de poussière ou de travail particulièrement intensif, intensifier les contrôles en fonction de la nécessité.



B

D



ALLARME:
TEMPERATURA ELEVATA

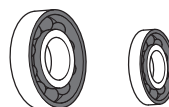
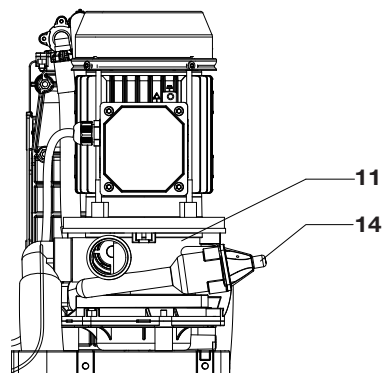
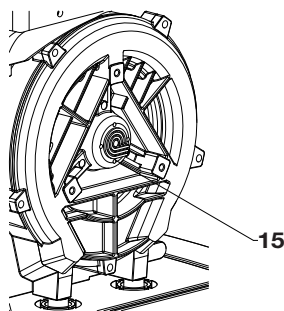

• Instructions pour naviguer dans les menus du Micro-Smart et modifier certains paramètres

Menus principaux

Au démarrage du Micro-Smart, le logo Cattani S.p.A. apparaît sur l'écran pendant 10 secondes avant que le menu principal soit visualisé.



Menu principal "A1"

Ce menu visualise les paramètres suivants: vitesse du moteur d'aspiration, totalisateur horaire de marche, température machine, présence et niveau de remplissage du séparateur d'amalgame et versions du software.



Cliquer  pour accéder au

Menu de contrôle "A2"

Cet écran visualise le nombre mises sous tension (Power Cycles), le nombre d'heures sous tension (Uptime), le nombre de mises en marche (Work Cycles), le nombre total d'heures de fonctionnement (Work Time), le nombre d'heures de fonctionnement de l'aspirateur ramené à 50 Hz et le nombre de mises en marche du ventilateur de refroidissement (Fan Cycles).

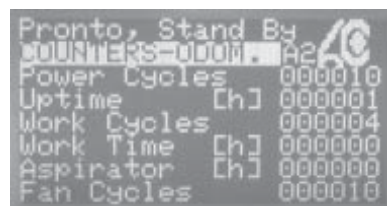

Flèche de droite 

Menu événements "A3"

Ce menu visualise les derniers événements ou alarmes survenus au Micro-Smart. Les événements sont indiqués par un numéro; se référer au tableau à la page 71 pour les identifier.

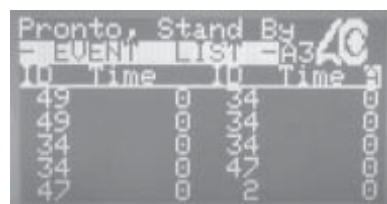

Menu de contrôle "A2"

COUNTERS – ODOM . A2		
POWER CYCLES	000000	Nombre mises sous tension de l'aspirateur
UPTIME [h]	000000	Nombre d'heures sous tension (moteurs éteints)
WORK CYCLES	000000	Nombre de mises en marche
WORK TIME [h]	000000	Nombre d'heures de fonctionnement de la machine
ASPIRATOR [h]	000000	Le nombre d'heures de fonctionnement de l'aspirateur ramené à 50 Hz
FAN CYCLES	000000	Nombre de mises en marche du ventilateur de refroidissement

Menus secondaires

Cliquer sur la touche entrée  pour accéder aux menus secondaires.

En cliquant la touche  vous entrez dans les autres menus.

Drive Status (Etats machine)

Ce menu est accessible sans mot de passe. L'écran affiche des informations utiles sur le fonctionnement.

User Parameters (Paramètres utilisateur)

Insérer le mot de passe 0000123000 pour entrer dans ce menu.

Dans ce menu il est possible de régler la dépression maximum et de modifier la langue de l'écran.

System Parameters Setup (Paramétrages système)

Le mot de passe 0000456000 doit être inséré pour entrer dans ce menu.

Dans ce menu il est possible de régler certains paramètres techniques comme la temporisation d'arrêt.

Factory Settings Restricted Access (Réglages usine)

Ce menu n'est pas accessible à l'utilisateur. Seulement le fabricant peut y entrer.

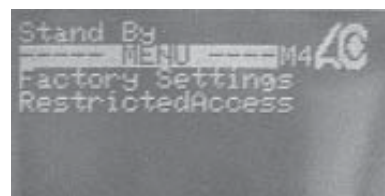
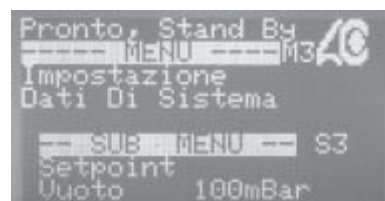
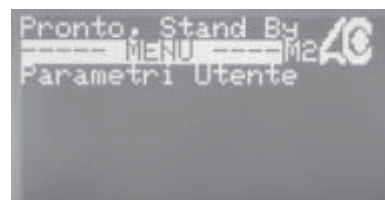
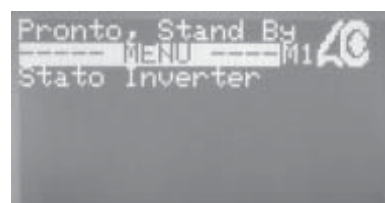
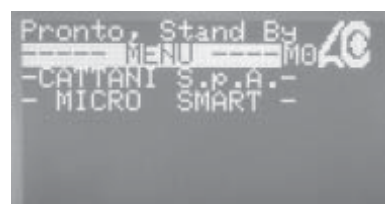
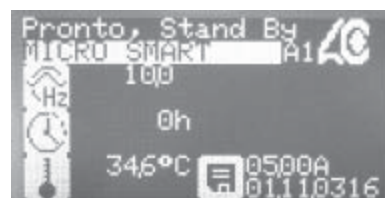

scroll down button
↓



Insérer les mots de passe



Le menu Drive Status est le seul menu accessible sans mot de passe.



Pour entrer dans les menus User Parameters et System Parameters Setup il faut insérer les mots de passe correspondants :



Mot de passe pour accéder au menu User Parameters « 0000123000 ».

Mot de passe pour accéder au menu System Parameters Setup est « 0000456000 ».

Quand vous vous trouvez dans le menu CATTANI S.p.A., utilisez les touches directionnelles  et  pour faire apparaître sur l'écran le menu Access Password Access Password 0000000000.

Cliquer sur la touche Entrée  : un curseur apparaît sur le dernier zéro à droite. Utiliser la touche  pour déplacer le curseur sur le sixième zéro à partir de la droite. En cliquant sur  le chiffre 1 apparaît.

Utiliser la touche  pour déplacer le curseur sur le zéro suivant puis cliquer sur  pour faire apparaître le chiffre 2.

Utiliser la touche  pour déplacer le curseur sur le zéro suivant puis cliquer sur  pour faire apparaître le chiffre 3.

Cliquer sur la touche Entrée  pour confirmer le mot de passe. Le curseur disparaît.

Cliquer  pour retourner au menu Cattani S.p.A.

A ce point il est possible de modifier certains paramètres du menu User Parameters.

Répéter le même procédé pour insérer le mot de passe 0000456000 et entrer dans le menu System Parameters Setup.

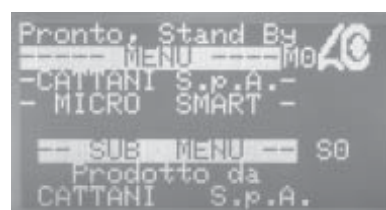
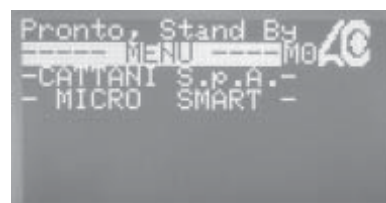

Menu Drive Status (Menu Etats machine)

Ce menu est accessible sans mot de passe. Il affiche différents paramètres techniques concernant les conditions de travail du Micro-Smart en temps réel. Les informations les plus consultées sont :

Blower Output Frequency (Fréquence de fonctionnement du moteur d'aspiration) (Valeur maxi. : 120 Hz)

Blower Output Voltage (Tension de fonctionnement du moteur d'aspiration) (Valeur maxi. : 220V)

Blower Overall Current (Intensité de fonctionnement du moteur d'aspiration) (Valeur maxi. : 4,3 A)

Pump Output (Centrifuge) Frequency (Fréquence de fonctionnement du séparateur centrifuge) (Valeur non variable : 75 Hz)

Pump Output (Centrifuge) Voltage (Tension de fonctionnement du séparateur centrifuge) (Valeur maxi. : 220V)

Pump Overall (Centrifuge) Bus Current (Intensité de fonctionnement du séparateur centrifuge) (Valeur maxi. : 3,2 A)

scroll down button

```
Pronto, Stand By
----- MENU ----- M1
Stato Inverter
```

```
Pronto, Stand By
----- MENU ----- M1
Stato Inverter

-- SUB MENU -- S0
Frequenza Attuale
Soffiante 0100Hz
```

```
Pronto, Stand By
----- MENU ----- M1
Stato Inverter

-- SUB MENU -- S1
Tensione Uscita
Soffiante 029[V]
```

```
Pronto, Stand By
----- MENU ----- M1
Stato Inverter

-- SUB MENU -- S2
Corrente
Soffiante 000A
```

```
Pronto, Stand By
----- MENU ----- M1
Stato Inverter

-- SUB MENU -- S3
Frequenza Uscita
Centrifuga 100Hz
```

```
Pronto, Stand By
----- MENU ----- M1
Stato Inverter

-- SUB MENU -- S4
Tensione Uscita
Centrifuga 037[V]
```

```
Pronto, Stand By
----- MENU ----- M1
Stato Inverter

-- SUB MENU -- S5
Corrente
Centrifuga 000A
```

System Temperature (Température Système)

Maximum Detected Temperature (Température maxi. effaçable détectée) (+ 60 °C : Alarme et Arrêt de l'aspirateur, réinitialisable)

Maximum Detected Temperature (Température maxi. absolue détectée) (+ 60 °C : Mémoire Température non réinitialisable)

Power Bus Voltage (Tension Bus) (Valeur maxi. : 390V)

Maximum Detected Power Bus Voltage (Tension maxi. Bus détectée) (Valeur maxi : 390 V)

Power Bus Ripple (Amplitude Bus)

Vacuum Set Point (Dépression maxi. réglage) (Valeur maxi. : 210 mbar)

Pronto, Stand By 
 MENU M1
 Stato Inverter
 SUB MENU S6
 Temperatura
 Dissipatore 348°C

Pronto, Stand By 
 MENU M1
 Stato Inverter
 SUB MENU S7
 Massima Temperat
 Memorizzata 362°C

Pronto, Stand By 
 MENU M1
 Stato Inverter
 SUB MENU S8
 Massima Temperat
 Assoluta 362°C

Pronto, Stand By 
 MENU M1
 Stato Inverter
 SUB MENU S9
 Tensione Bus
 Potenza 309 U

Pronto, Stand By 
 MENU M1
 Stato Inverter
 SUB MENU S10
 Massima Tensione
 BUS Memoriz. 323U

Pronto, Stand By 
 MENU M1
 Stato Inverter
 SUB MENU S11
 Ripple Bus
 Potenza 000 U

Pronto, Stand By 
 MENU M1
 Stato Inverter
 SUB MENU S12
 Livello Quoto
 -01 mBar

scroll down button

Run mode (Mode de marche) (il décrit le mode de marche de la machine)

Menu User Parameters (Menu paramètres utilisateur)

Pour entrer dans ce menu il faut insérer le mot de passe 0000123000 (suivre les instructions à la page 59).

Vacuum Set Point (Dépression maxi. réglage)

C'est la valeur maxi. programmée.

Cliquer sur la touche Entrée  pour faire apparaître le curseur. La valeur peut être modifiée à l'aide des touches directionnelles 

Cliquer encore sur la touche Entrée  pour confirmer.

Language (Langue)

Il est possible de choisir entre italien (0), anglais (1), français (2) ou allemand (3) pour la langue de l'écran.

Cliquer sur la touche Entrée  pour activer le curseur et utiliser les touches directionnelles  pour sélectionner 0, 1, 2 ou 3.

Cliquer encore sur la touche Entrée  pour confirmer la modification.

Generated Code (Code machine)

Ce code est créé par Cattani S.p.A. Chaque machine possède un code. A présent ce code n'est pas utilisable.

Activation Code (Code activation)

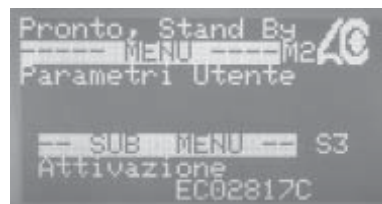
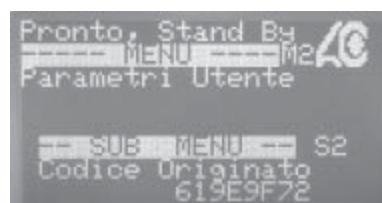
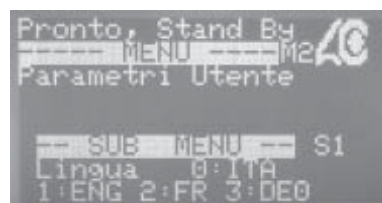
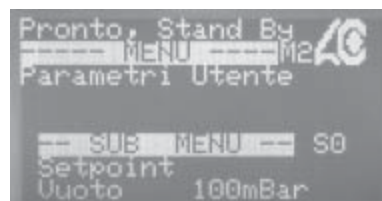
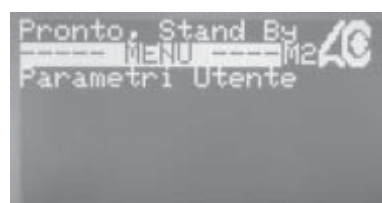
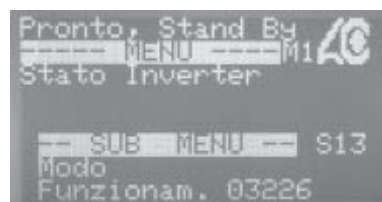

Non utilisable à présent.



scroll down button

Menu System Parameters Setup (Menu Paramétrages Système)

Pour entrer dans ce menu et/ou modifier certains paramètres il faut insérer le mot de passe 0000456000 (suivre les instructions à la page 59).

Pour modifier les paramètres de ce menu faire défiler les pages des sous-menus avec les touches   jusqu'à ce que le paramètre qu'on veut modifier apparaisse.

Cliquer sur la touche Entrée  pour activer le curseur et utiliser les touches directionnelles   pour afficher la valeur désirée.

Cliquer sur la touche Entrée  pour valider et continuer.

Tous les paramètres peuvent être réglés.

Min. Vacuum Setting (Réglage de la dépression maximum au niveau 1 bas)

Max. Blower Output Frequency at the Min. Setting (Réglage de la fréquence maximum du moteur d'aspiration au niveau 1 bas)

Blower Current Limit at the Min. Setting (Réglage de l'intensité maxi. du moteur d'aspiration au niveau 1 bas)

Medium Vacuum Setting (Réglage de la dépression maximum au niveau 2 moyen)

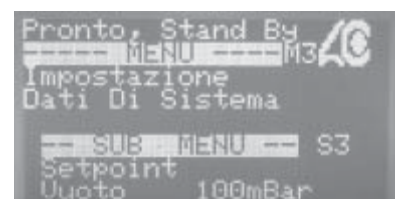
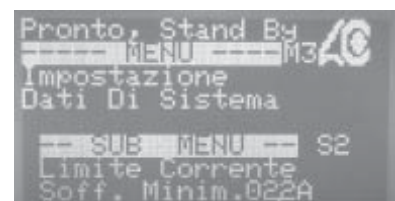
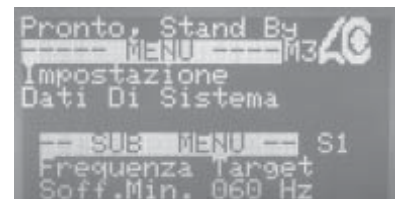
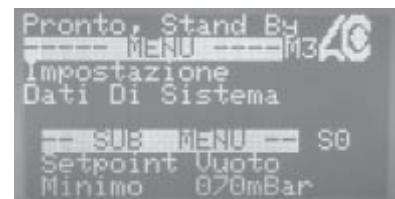

scroll down button

Max. Blower Output Frequency at the Medium Setting (Réglage de la fréquence maximum du moteur d'aspiration au niveau 2 moyen)

Blower Current Limit at the Medium Setting (Réglage de l'intensité maximum de l'aspirateur au niveau 2 moyen)

Surgery Vacuum Setting (Réglage de la dépression maximum au niveau 3 haut)

Max. Blower Output Frequency at the Surgery Setting (Réglage de la fréquence maximum du moteur d'aspiration au niveau 3 haut)

Blower Current Limit at the Surgery Setting (Réglage de l'intensité maxi. du moteur d'aspiration au niveau 3 haut)

Off Delay Time (Réglage de la temporisation d'arrêt) (Valeur maxi. : 300')

Pump Off Delay (Centrifuge) Time (Réglage de la temporisation d'arrêt du séparateur centrifuge) (Valeur maxi. : 30')

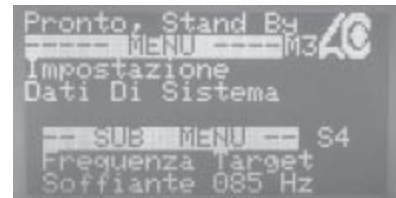

```
Pronto, Stand By
----- MENU ----- M3 AC
Impostazione
Dati Di Sistema

--- SUB MENU --- S4
Frequenza Target
Soffiante 085 Hz
```

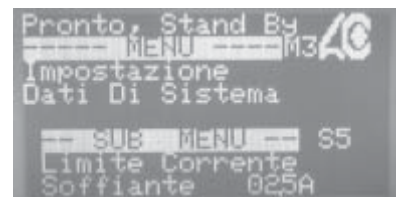

```
Pronto, Stand By
----- MENU ----- M3 AC
Impostazione
Dati Di Sistema

--- SUB MENU --- S5
Limite Corrente
Soffiante 025A
```

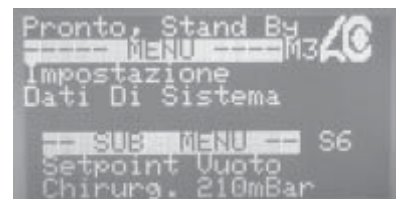

```
Pronto, Stand By
----- MENU ----- M3 AC
Impostazione
Dati Di Sistema

--- SUB MENU --- S6
Setpoint Vuoto
Chirurg. 210mBar
```

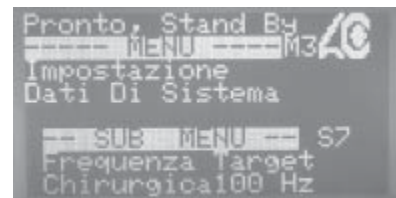

```
Pronto, Stand By
----- MENU ----- M3 AC
Impostazione
Dati Di Sistema

--- SUB MENU --- S7
Frequenza Target
Chirurgica 100 Hz
```

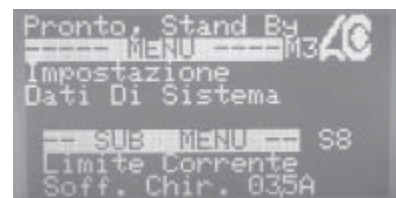

```
Pronto, Stand By
----- MENU ----- M3 AC
Impostazione
Dati Di Sistema

--- SUB MENU --- S8
Limite Corrente
Soff. Chir. 035A
```

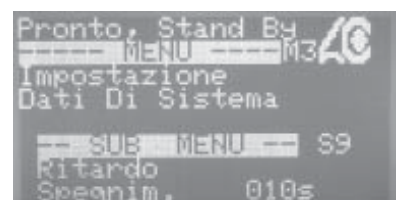

```
Pronto, Stand By
----- MENU ----- M3 AC
Impostazione
Dati Di Sistema

--- SUB MENU --- S9
Ritardo
Spegnim. 010s
```

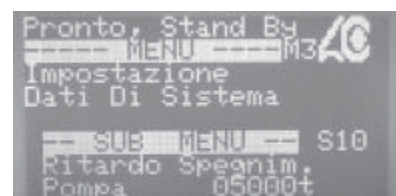

```
Pronto, Stand By
----- MENU ----- M3 AC
Impostazione
Dati Di Sistema

--- SUB MENU --- S10
Ritardo Spegnim.
Pompa 05000t
```

↓
Scroll down button

Blower Off Delay Time (Réglage de la temporisation d'arrêt de l'aspirateur) (Valeur maxi. : 300')

Running Options (Options Système)

(Activation ou désactivation du détecteur du niveau d'amalgame)

Sur 0 : absence séparateur amalgame

Sur 2 : présence du séparateur amalgame

Drive Commands (Calibration Inverter)

Procédure permettant la calibration de certains paramètres par le fabricant.

Adresse Modbus

Menu non encore utilisé.

Network address

Adresse réseau du Micro-Smart pour la visualisation Zig-Bee.

Zig-Bee Minimum Channel

Sélection du canal minimum avec lequel le Micro-Smart peut communiquer.

Zig-Bee Maximum Channel

Sélection du canal maximum avec lequel le Micro-Smart peut communiquer.

```
Pronto, Stand By
----- MENU ----- M3
Impostazione
Dati Di Sistema

-- SUB MENU -- S11
Kitardo Spegnim.
Ventola 0300s
```

```
Pronto, Stand By
----- MENU ----- M3
Impostazione
Dati Di Sistema

-- SUB MENU -- S12
Opzioni
Utilizzate 00000
```

```
Pronto, Stand By
----- MENU ----- M3
Impostazione
Dati Di Sistema

-- SUB MENU -- S13
Comandi ad
Inverter 00000
```

```
Stand By
----- MENU ----- M3
System
Parameters Setup

-- SUB MENU -- S14
MODBUS
Address 002
```

```
Stand By
----- MENU ----- M3
System
Parameters Setup

-- SUB MENU -- S15
Network
Address 104
```

```
Stand By
----- MENU ----- M3
System
Parameters Setup

-- SUB MENU -- S16
zigBee Channel
Minimum 11
```

```
Stand By
----- MENU ----- M3
System
Parameters Setup

-- SUB MENU -- S17
zigBee Channel
Maximum 26
```

Scroll down button

- *Instruction pour la calibration de la communication sans fil Zig-Bee*

Sélectionner l'adresse réseau de la machine.
(min. 100)
(max. 110)

Insérer la clé USB Zig-Bee (ETRX2USB) dans l'ordinateur et lancer le programme d'installation du périphérique.

Installer sur l'ordinateur le programme "Smart System Monitor" fourni par la société CATTANI S.p.a.

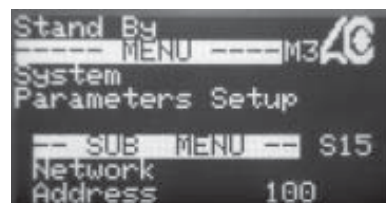

Une fois le programme lancé, l'écran d'accueil s'affiche. Au bout de 10 secondes le menu principal apparaît.



Cliquer sur le menu "SERVICE" pour ouvrir la page de recherche des machines.



Cliquer sur l'onglet "recherche de machines disponibles", le programme lance une recherche qui peut prendre quelques secondes. Une fois la recherche terminée, le programme affiche les différents Micro-Smart et leur "code machine" respectifs.
NB : il peut être nécessaire de relancer plusieurs fois la recherche.

Une fois les différentes machines trouvées, retournez sur l'écran d'accueil pour visualiser les paramètres.

Sélectionner dans le menu déroulant le Micro-Smart à visualiser.

Vous pouvez maintenant visualiser tous les paramètres de fonctionnement.

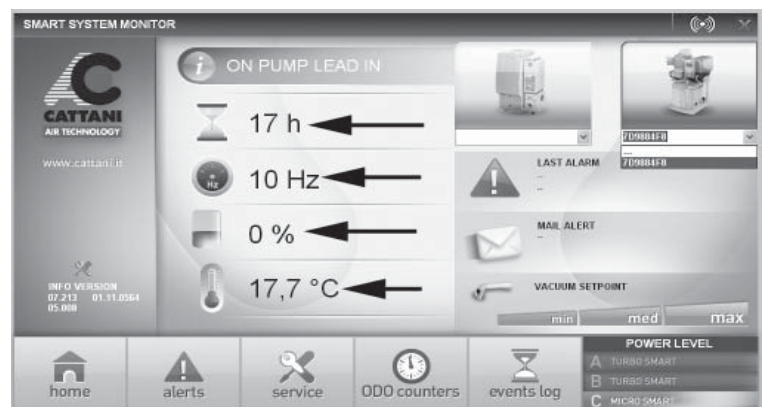
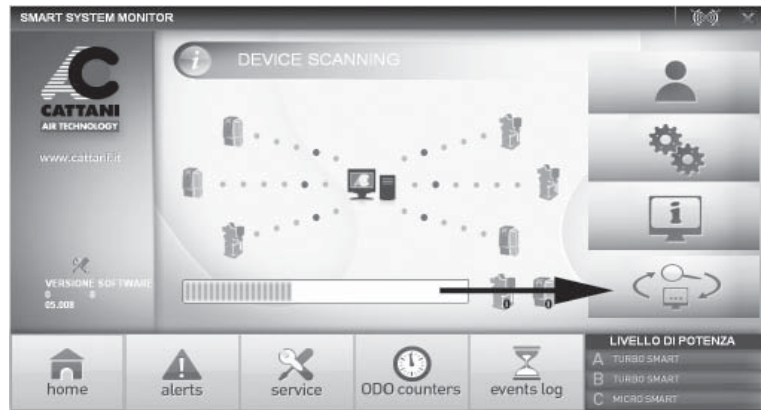

En cliquant sur l'onglet "service", vous pouvez accéder à 3 différents menus, dont 2 ont un accès verrouillé.

Pour entrer dans le menu "PARAMÈTRES UTILISATEUR" taper le code 123000 et valider sur "OK".

Ce menu permet de sélectionner différentes langues et de régler le niveau de dépression désiré.

Pour entrer dans le menu "PARAMÉTRAGE SYSTÈME" taper le code 456000 et valider sur "OK".



Ce menu permet de visualiser et de modifier tous les paramètres.

Le menu “ÉTAT INVERTER” ne requiert aucun code. Ce menu permet de visualiser les différents paramètres de fonctionnement de la machine.

Depuis le menu principal, cliquer sur l’onglet “E-MAIL” pour choisir le destinataire (technicien ou praticien) vers lequel les alertes e-mail seront envoyées.

En cas de dysfonctionnement, une fenêtre d’alerte s’affichera à l’écran et un e-mail sera envoyé au contact défini dans le point précédent.

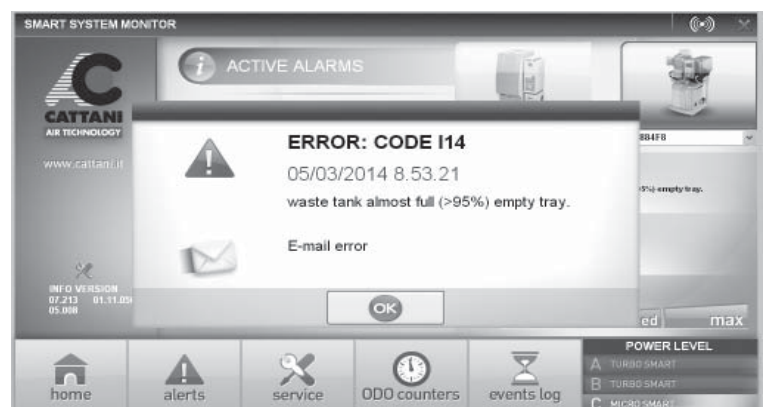
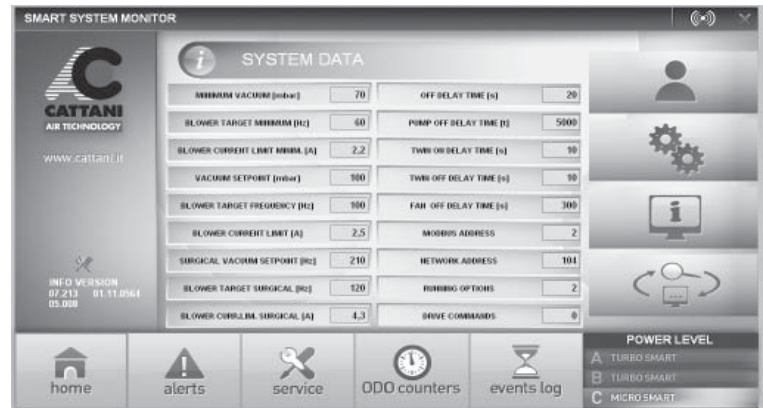

Toutes les alertes éventuelles générées durant la journée sont affichées avec un code erreur et une description dans l'onglet "ALERTS".

L'historique complet de toutes les alertes peut être consulté dans l'onglet "EVENTS LOG".

A chaque mise sous tension toutes les données s'affichent dans le totalisateur de marche, qui peut être consulté dans l'onglet "ODO-COUNTERS".

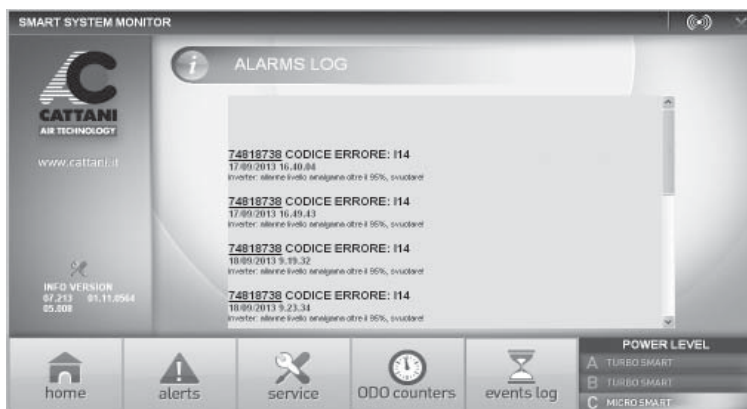
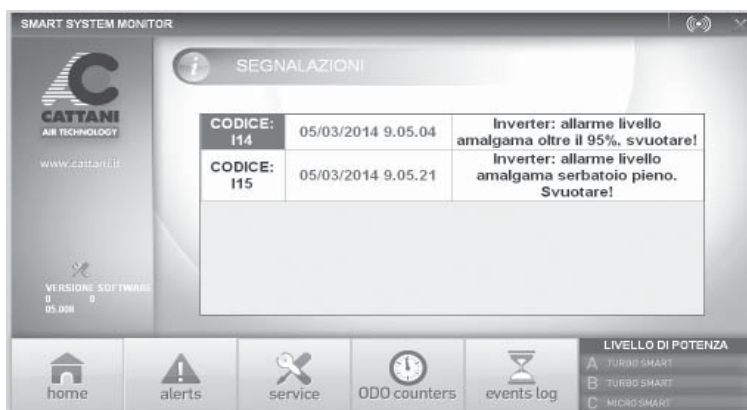

• Description des alarmes

Code Alarme AC100	DESCRIPTION	SOLUTION
0	Alarme mémoire microcontroller	Contacteur le technicien
32	Alarme mémoire microcontroller	Contacteur le technicien
33	Court-circuit dû à un des deux moteurs	Contrôler d'où vient le court-circuit et l'éliminer
34	Court-circuit avant le démarrage des moteurs	Contacteur le technicien (changer la platine)
35	Les condensateurs n'ont pas été chargés	Contacteur le technicien (changer la platine)
36	Température trop élevée (la température a dépassé la limite maxi. consentie)	Ventiler le local technique
37	Surconsommation du moteur d'aspiration	Contrôler le fonctionnement du moteur d'aspiration (blocage ou friction excessive)
39	Surtension des condensateurs (les condensateurs ont dépassé la limite maxi. de tension)	Contrôler la tension de la ligne d'alimentation (maxi. 260V)
40	Court-circuit de la centrifugeuse	Éliminer le court-circuit
41	Court-circuit de la platine sur la sortie de la centrifugeuse	Remplacer la platine
42	Surconsommation instantanée de la centrifugeuse (la centrifugeuse a dépassé la limite consentie)	Éliminer les siphons sur les tuyauteries ou vérifier le fonctionnement de la centrifugeuse (blocage ou friction excessive)
43	Surconsommation prolongée de la centrifugeuse (la centrifugeuse a dépassé la limite consentie)	Éliminer les siphons sur les tuyauteries ou vérifier le fonctionnement de la centrifugeuse (blocage ou friction excessive)
45	Le détecteur du niveau d'amalgame n'est pas relié	Relier le détecteur du niveau d'amalgame
46	Niveau Amalgame > 95%	Remplacer le conteneur d'amalgame le plus tôt possible
47	Niveau Amalgame > 100%	Remplacer le conteneur d'amalgame
48	Le tuyau de détection de dépression n'est pas relié	Relier le tuyau de détection de dépression à la centrifugeuse
49	Interrupteur thermique éteint	Rétablir la température dans la salle des machines

- *Avis importants*
- *Transport et stockage*
- *Transport des appareils usagés*

• *Avis importants*

- Les équipements sont garantis pendant un an après la date de vente, à condition que la fiche de garantie correctement remplie (date de vente, nom du vendeur, nom de l'utilisateur) soit retournée au fabricant.
- La garantie et la responsabilité du fabricant cessent lorsque les équipements sont traités avec des produits impropres ou différents de ceux recommandés par le fabricant, lorsque les équipements sont mal employés ou altérés par toute opération effectuée par des personnes non autorisées par le fabricant.
- Le fabricant, les concessionnaires, les agents et les techniciens autorisés sont à disposition pour tous conseils, renseignements et pour fournir la documentation, les pièces de rechange et tout autre renseignement utile.
- Le fabricant se réserve le droit de modifier sa production sans préavis en fonction des progrès techniques, des nécessités fonctionnelles, des nouvelles normes et de la difficulté concernant la disponibilité des produits ou des produits semi-finis sur le marché.
- Sur le site internet **www.cattani.it** on peut trouver nos manuels techniques **mis à jour**. Nous recommandons de les consulter surtout pour les mises à jour concernant la **sécurité**.
- Micro-Smart est un appareil EEE, donc soumis à la législation DEEE (Déchets d'Équipements Électriques et Électroniques).

• *Transport et stockage*

- Températures extrêmes de transport et de stockage des équipements emballés : de - 10 °C à + 60 °C.
- Les colis ne doivent pas être exposés à l'eau ou aux éclaboussures et doivent être stockés dans un endroit où le taux d'humidité ne dépasse pas 70%.
- On peut superposer seulement trois colis ayant le même poids.

• *Transport des appareils usagés*

- Avant d'emballer les appareils, nous conseillons de nettoyer et désinfecter l'aspirateur avec Fast & Steril 3 (voir paragraphes: " Signaux et avertissement" et "Entretien ordinaire").
- Vider tous les tuyaux et raccords (même ceux incorporés dans la machine) et les fluides restants (y compris le liquide désinfectant qui pourraient endommager les parties électroniques. Retirer la cassette d'amalgame, ajouter le désinfectant, refermer la cassette avec le couvercle hermétique. Lorsque la machine est sèche (extérieur et intérieur), fermer toutes les entrées et sortie avec les bouchons plastiques. Mettre une cassette d'amalgame neuve et envelopper séparément dans un plastique étanche la partie mécanique et la boîte de commande électronique.
- Enfermer l'appareil dans un sac en polyéthylène et l'emballer dans un carton triple cannelure.



MICRO SMART

SUSTAINABLE PROGRESS

INHALTSVERZEICHNIS

Allgemeine Betriebsdaten Saugmaschine für die Zahnarztpraxis Micro-Smart.....	74
Einleitung	75
Signale und Hinweise	75
Montage und Inbetriebnahme.....	76
Ordentliche Wartung	79
Außerordentliche Wartung	80
Anleitung zum Steuern der Micro-Smart Menüs und zum Abändern von Parametern..	81
Anweisungen für das Einstellen der Zig-Bee-Kommunikation (drahtlos).....	90
Alarmbeschreibung	95
Wichtige Hinweise.....	96
Transport und Lagerung	96
Transport von Gebrauchtgeräten	96
Zeichnungen.....	121

- *Allgemeine Betriebsdaten Saugmaschine für die Zahnarztpraxis Micro-Smart*

Modell	Micro-Smart
Nennspannung	230 V ~
Nennfrequenz	50/60 Hz
Nennstrom	6,3 A
Schutztyp gegen direkte und indirekte Berührung	Klasse I
Betriebsweise	Dauerbetrieb
Schutz gegen Feuchtigkeit	normal
Schutzgrad gegen direkte und indirekte Berührung	Typ B
Höchstleistungsaufnahme	1,30 kW
Höchstdurchsatz	55 m ³ /h
Max. Förderhöhe bei Dauerbetrieb	2100 mm H ₂ O
Schalldruckpegel ohne Gehäuse von 60Hz bis 120Hz	von 64 dB (A) bis 71 dB (A)
Schalldruckpegel Absauggruppe mit Plastikgehäuse von 60Hz bis 120Hz	von 63 dB (A) bis 68,5 dB (A)
Schalldruckpegel mit Gehäuse für Innenmontage von 60Hz bis 120Hz	von 41 dB (A) bis 48 dB (A)
Schalldruckpegel mit Gehäuse für Außenmontage von 60Hz bis 120Hz	von 54,5 dB (A) bis 61,2 dB (A)

~	Wechselstrom	IEC 417-5032
⊕	Schutzerdung	IEC 417-5019
⚡	Schutzgrad gegen direkte und indirekte Berührung	CEI EN 60601-1
○	Offen (Stromversorgung unterbrochen)	IEC 417-5008
I	Geschlossen (Stromversorgung angeschlossen)	IEC 417-5007

Schalldruckpegel gemäß ISO-Norm 3746-1979 (E) gemessen.
 Parameter: r = 1,5 - Hintergrundgeräusch: 34 dB (A) - Messgerät: Brüel & Kjær
 Typ 2232.

- *Einleitung*
- *Signale und Hinweise*

- *Einleitung*

Diese Präsentation dient der Darstellung der Montage und der Inbetriebnahme der Anlage und der Information bezüglich der Gefahren und der notwendigen Vorsichtsmaßnahmen.

Während der Montage, der Inbetriebnahme, des Betriebes und der Wartung des Micro-Smarts sollte das Handbuch jederzeit als Ratgeber verfügbar sein.

Auf der Internetseite www.cattani.it finden Sie unsere **aktualisierten** Handbücher.

Wir empfehlen, diese Handbücher und insbesondere die enthaltenen Aktualisierungen betreffend **Sicherheit** zu lesen.

- *Signale und Hinweise*

- *Stromschlaggefahr, auch 230 V \sim können tödlich sein!*



- *Biologisches Risiko, Infektionen durch ansteckende Krankheiten.*



- *Allgemeines Gefahrensignal.*



- *Personenschutzvorrichtungen für anstrengende Arbeiten.*



- *Personenschutzvorrichtungen für ansteckende Krankheiten.*



- *Hohe Temperaturen.*



- *Im Maschinenraum dürfen keine entflammaren, korrosiven oder explosiven Materialien stehen.*



- *Vorgeschriebene Fluss- und Drehrichtung.*



Nicht immer kann mit einem Signal der erforderliche Gefahrenhinweis gegeben werden, daher muss der Benutzer die Hinweise aufmerksam lesen und diese beachten.

Das Nichteinhalten eines Signals oder eines Gefahrenhinweises kann dem Benutzer oder dem Patienten Schaden zufügen.

Die Schutzvorrichtungen dürfen nicht abmontiert, die Maschinen und ihre Betriebsweise nicht verändert werden.

Trotz unserer Bemühungen könnten die Hinweise nicht vollständig sein, daher bitten wir den Anwender, selbst auf uns möglicherweise entgangene Gefahrenquellen zu achten und uns diese mitzuteilen.

• Montage und Inbetriebnahme

• Empfohlene Vorsichtsmaßnahmen

Vor dem Auspacken die Außenseite der Verpackung kontrollieren. Im Falle, dass der Shockwatch-Indikator rot geworden ist oder die Verpackung beschädigt wurde, das Material annehmen, sich aber die Möglichkeit vorbehalten, das Gerät zu kontrollieren.

Die Maschine anhand der auf der Verpackung abgebildeten Anweisungen auspacken. Wir empfehlen, den Karton ordnungsgemäß zu entsorgen (er ist wiederverwertbar). Die Kunststoffabdeckungen, die alle Ein- und Auslässe des Gerätes bedecken, aufbewahren, da sie bei Bewegung oder Transport der Maschine benutzt werden müssen.

Das Gerät muss von einem Techniker montiert werden, der über die geeigneten Werkzeuge verfügt und erfahren ist. Die Saugmaschine muss an einem sauberen Ort, fern von Wärmequellen, Feuchtigkeit und Staub, aufgestellt werden. Die im Freien (auf einem Balkon, Veranda oder im Garten) aufgestellten Maschinen vor Regen, Feuchtigkeit, Frost und direkter Sonneneinstrahlung schützen.

Für die Außenmontage kann die Maschine mit einem speziellen Gehäuse geliefert werden, das mit doppeltem Isoliertdach, Frostschutzanlage und Belüftungsanlage ausgestattet ist (letztere sind beide mit festem Thermostat für die automatische Temperaturregelung versehen).

Es muss sichergestellt werden, dass die Lufttemperatur im Maschinenraum zwischen mindestens +5 °C und höchstens +35 °C liegt.

Die Maschinen mit Gehäuse (für Außen- und Innen-Montage) können mit Frostschutzanlage geliefert werden. Für die Entwicklung einer Belüftungs- oder Klimaanlage des Maschinenraums einen Installateur kontaktieren. Die Patienten dürfen zum Maschinenraum keinen Zugang haben. Falls ein solcher Raum nicht verfügbar ist, müssen die Maschinen durch ein geeignetes Schutzgehäuse geschützt werden, das nicht leicht zu entfernen ist. Schutzmaßnahmen und Gefahrenschilder vorbereiten, um Stromschläge, Brände, Explosionen (eine unwahrscheinliche, aber nicht ausschließbare Möglichkeit) und das Austreten von kontaminierter Luft oder von Flüssigkeiten zu vermeiden. Es sind ausschließlich die vom Hersteller der Maschine entwickelten Schutzgehäuse für Außen- und Innen-Montage zu verwenden.

Im Maschinenraum dürfen keine entflammaren Materialien stehen. Überwachen Sie stets, dass es keine Möglichkeit für das Gasaustreten gibt. Niemals ein beschädigtes Gerät an das Stromnetz anschließen. Keine Verlängerungen und Doppelstecker/-steckdosen verwenden. Bevor das Gerät mit der Stromversorgung verbunden wird, überprüfen Sie, dass das Stromnetz die Normen CEI 64-8 erfüllt und dass es einen Motorschutzschalter und einen Fehlerstromschutzschalter (Klasse A oder B) (16A) gemäß den Normen EN 61008-1 gibt.

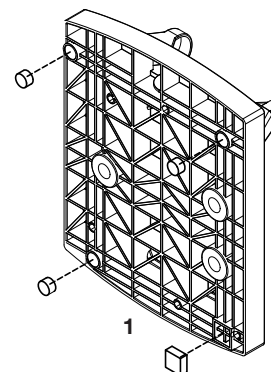
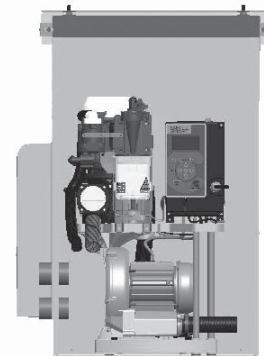
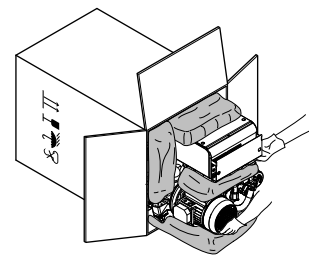

Heller Bodenbelag aus Holz, Linoleum, Gummi oder Marmor kann beim Kontakt mit dem Vibrationsschutz aus Gummi **(1)** seine Farbe ändern oder dunkle Flecken bekommen. Daher ist eine Kunststoffunterlage oder ein anderes für diesen Zweck geeignetes Produkt zwischen Vibrationsschutz und Boden zu verwenden, um den Bodenbelag vor Abriebspuren zu schützen.

• Montage

Bevor das Gerät mit der Rohrleitung der Zentralanlage verbunden wird, ist sicherzustellen, dass die Saugleitungen sauber sind, denn schwere Fremdkörper könnten zu einer Beschädigung des Gerätes führen.

Das mit der Saugmaschine gelieferte hellgraue PVC-Saugrohr **(3)** muss mit dem 30 mm Ø Rohrträger **(2)** („Saugleitung“) verbunden werden. Das Ende desselben Saugrohres muss mit der aus den Dentaleinheiten kommenden Saugleitung **(2b)** verbunden werden.

Den schwarzen temperaturresistenten Luftauslass **(4b)** (mit Metallspirale) mit dem 30 mm Ø Rohrträger („Absaugguteinlauf“) **(4)** verbinden. Das andere Ende des Rohrs mit dem antibakteriellen Filter **(5)** - möglicherweise durch den gelieferten Schalldämpfer **(5a)** - verbinden. Am Ausgang des antibakteriellen Filters muss die noch warme ausgetragene Luft ins Freie abgelassen werden.

Verbinden Sie auch den 18 mm Ø Rohrträger **(6, Seite 79)** mit dem Flüssigkeitsabfluss. In der mit Hydrozyklon ausgestatteten Version lässt die Saugmaschine das Sekret aufgrund seiner Schwere nur in den Abfluss. Die Flüssigkeit kann niemals nach oben austreten. Verbinden Sie den 10 mm Ø Rohrträger **(8, Seite 78)** („Notüberlaufventil“) mit dem Flüssigkeitsabflussrohr. In der ohne Hydrozyklon ausgestatteten Version verbinden Sie den 11 mm Ø Rohrträger **(6b)** mit dem Flüssigkeitsabfluss. Die Leitung zwischen der Maschine und der Absaug- und Abflussanlage ist biegsam, um die Vibrationen der Saugmaschine zu dämpfen.

Gewöhnlich geht die Saugleitung durch den Fußboden. In der Nähe der Saugmaschine steigt sie um 30 cm, um bis zum Rohrträger **(2)** hinaufzureichen (Abb. A und B, Seite 121).

Auch im Falle, dass der Micro-Smart auf einem tieferen Stockwerk als die Dentaleinheiten installiert ist, muss die Saugleitung nicht senkrecht in den Zentrifugalabscheider eintreten. Lieber einige Meter Rohr horizontal auf dieselbe Fläche der Maschine verlegen und ein

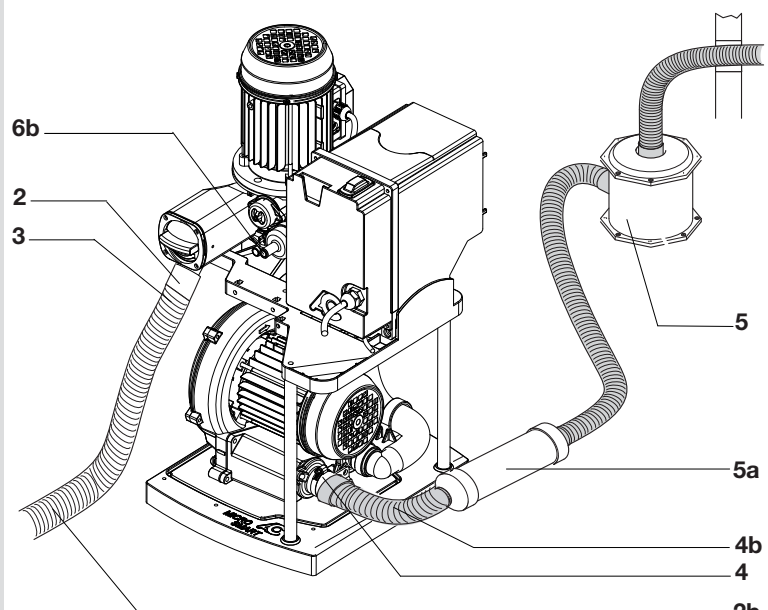
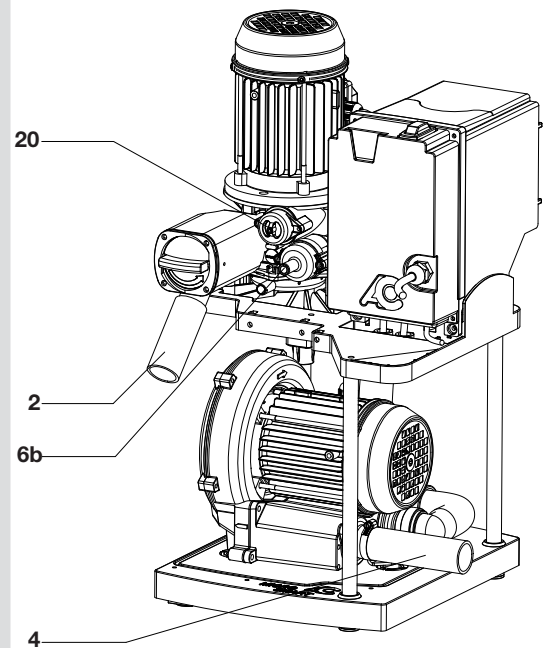

biegsames Rohr in den Eingang des zentrifugalen Abscheiders stecken (Der zentrifugale Abscheider ist auf einer höheren Fläche) (Abb.B, Seite 121). Die abgesaugte Flüssigkeit wird von der Saugmaschine abgesaugt.

Nach der Montage ist das Versorgungskabel an das Stromnetz nach der Norm EN 61008-1 anzuschließen.

Zuletzt ist die Steuerleitung der Dentaleinheit an die Saugmaschine anzuschließen. Es ist sicherzustellen, dass der Kontakt von der Dentaleinheit potenzialfrei ist.

- **Inbetriebnahme, Abnahme und Einweisung des Personals**

Nach der Montage und dem Anschluss der Absauganlage wird der Netzschalter auf ON gestellt. Die im Schalter unten angebrachte Lampe schaltet sich ein und bei Übertragung des Signals von einer der angeschlossenen Dentaleinheiten setzt der Saugbetrieb ein.

Um den Betrieb des Micro-Smarts zu überprüfen, ist es ratsam dynamische Tests durchzuführen (Richten Sie sich nach der Abb. E auf Seite 124) und das Micro-Smart Arbeitsdiagramm (Abb. F, Seite 125) nachzuschlagen.

Die Einweisung des Personals bezüglich des Gebrauchs und der ordentlichen Wartung der Absauganlage muss mit einer noch nicht verwendeten und folglich noch nicht kontaminierten neuen Maschine durchgeführt werden.

Das Praxispersonal darauf hinweisen, die Betriebsphasen des Micro-Smarts auf dem Display zu verfolgen, die Warnhinweise zu protokollieren, eine gute Wartung mit Puli-Jet plus new (A) durchzuführen - Pulse Cleaner (B) ist zu verwenden - und die Antischaumtabletten (C) regelmäßig zu benutzen.

- **Betrieb**

Die Absauggruppe 9 (durch das Rohr 10) schafft das Vakuum im Zentrifugalabscheider (11). Die aus den Dentaleinheiten kommende Flüssigkeit wird durch die Sammelleitung (2) dem Zentrifugalabscheider (11) zugeführt.

Der Zentrifugalabscheider trennt die Luft von der Flüssigkeit: die Luft wird ins Freie durch ein Rohr (4) abgelassen, während die Flüssigkeit durch das mit dem Rohrträger (6b) (in der Version ohne Hydrozyklon) oder (6) (in der Version mit Hydrozyklon) verbundene Abflussrohr dem Abfluss zugeführt wird.

Der Abscheider (11) startet vor der Absauggruppe (9). Dadurch wird vor dem Starten der Absaugung Sekret abgelassen, welches sich im Abscheider gesammelt haben kann. Außerdem hält ein Zeitschalter (regulierbar) den Motor für min. 10 - max. 120 Sekunden am Laufen, wenn die Maschine ausgeschaltet wird.

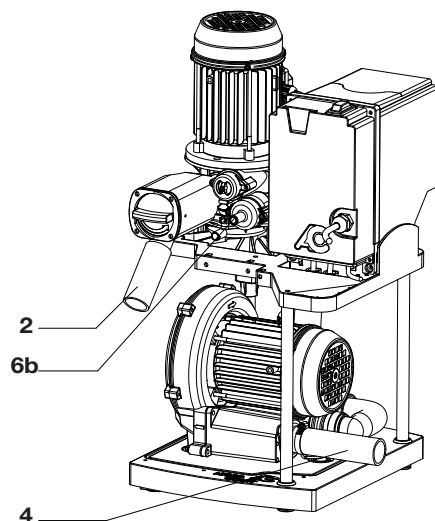
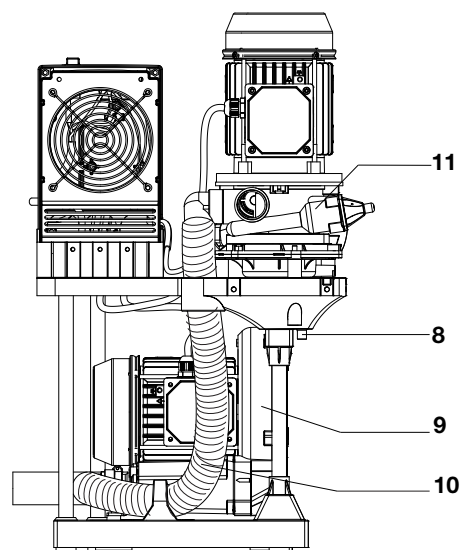
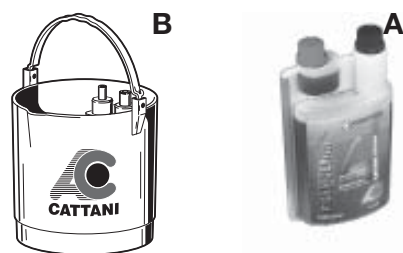

• *Ordentliche Wartung*

• **Amalgamabscheider gemäß den Normen ISO 11143**

Auf Anfrage liefern wir den Micro-Smart auch mit dem Amalgamabscheider „Hydrozyklon ISO 5,5 l/min.“ (komplett mit Gebrauchsanweisung).

Die ordentliche Wartung muss entsprechend eingewiesenen Praxispersonal anvertraut werden.

• Wir bitten, auf alle Warnhinweise besonders zu achten und sich mit Schutzbrille, Handschuhen und Einwegschrürze zu schützen.

Taglich (besonders am Abend oder mehrmals je nach Bedarf)

- Das Display auf eventuelle Alarmmeldungen kontrollieren. Bei Warnhinweisen den Techniker kontaktieren.
- Am Abend eine Puli-Jet plus new Desinfektionsmittellosung mit Entkalkungsmittel **(A)** ansaugen (Pulse Cleaner **(B)** ist zu verwenden).
- Die Absaugfilter des Behandlungsstuhls reinigen, die Abfalle (besonders das Amalgam) gema den gultigen Normen entsorgen und die desinfizierenden Antischaumtabletten **(C)** an denselben Filtern anbringen.
- **Vor jedem Eingriff am Gerat ist die Stromversorgung zu unterbrechen.**

Den Filter der Absauganlage reinigen.

Gelegentlich je nach Bedarf

- Kontrollieren, dass die Beluftung des Absauggerats nicht behindert wird.
- Im Maschinenraum darf nichts stehen, was nicht zur Maschine gehort; dies gilt besonders fur entflammbare Materialien. Überwachen Sie stets, dass sich keine korrosiven, entflammbaren oder explosiven Gemische bilden.



ALLARME:
TEMPERATURA ELEVATA

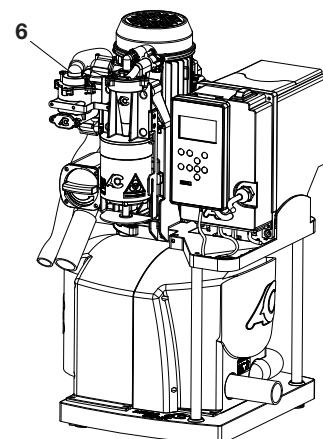
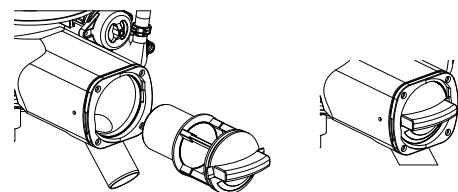
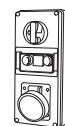
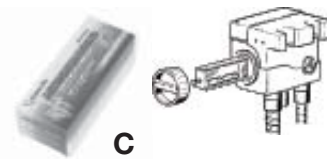
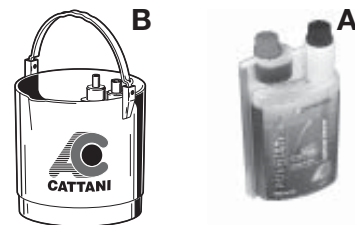

• Außerordentliche Wartung

Mit der außerordentlichen Wartung ist ein kompetenter Techniker zu beauftragen, der über Originalersatzteile verfügt.

- Auf alle Warnhinweise besonders achten und sich mit Schutzbrille, Handschuhen und Einwegschrürze schützen.
- Den Zustand der ordentlichen Wartung überprüfen und sicherstellen, dass Magnolia-Produkte verwendet werden.
- Vor jedem Eingriff am Gerät sind einige Waschgänge mit Fast&Steril 3 (D) durchzuführen (15 Minuten für eine komplette Desinfektionswirkung warten).

Alle 12 Monate empfohlene Kontrolle *

- Auf dem Display die aufgezeichneten Höchsttemperaturen und Alarmsignale überprüfen. Eingreifen, wenn nötig.
- Falls festgestellt wird, dass die ordentliche Wartung nicht korrekt / gar nicht durchgeführt wird oder ungeeignete Produkte verwendet werden, das Personal anweisen und den Praxisverantwortlichen informieren. Die Garantie des Herstellers verfällt, wenn die Geräte mit von den angegebenen Produkten abweichenden Produkten behandelt werden.
- Die Betriebsgeräusche der Absauganlage überprüfen (siehe Seite 74).
- Mit einem trockenen Druckluftstrahl (der Druck darf 2 bar nicht überschreiten) den Lüfter und den Kühlkörper der Platine entstauben. Mit einem trockenen Druckluftstrahl von 6 bar sind auch die kleinen Löcher auf der Frontabdeckung des Saugaggregats (15) zu reinigen.

Alle 18-24 Monate empfohlene Kontrolle

- Den Zustand der Kunststoffschläuche überprüfen, besonders die unter Druck stehenden Schläuche, die den Zentrifugalabscheider (11) und den Hydrozyklon ISO verbinden. Wir empfehlen, diese Schläuche alle 18 - 24 Monate zu ersetzen.
- Die Betriebsbedingungen des Zentrifugalabscheiders (11) und des Überdruckventils (14) überprüfen.

Alle 10.000/15.000 Betriebsstunden empfohlene Kontrolle

- Bei Demontage eines Geräteteils sind die entsprechenden Dichtungsringe oder Dichtungen auszutauschen.
- Die Lager der Motoren ersetzen.

(*) Der empfohlene Wartungsrythmus ist eine ungefähre Angabe. Bei Arbeiten, die viel Staub produzieren oder besonders intensiv sind, die Wartungsintervalle den Anforderungen entsprechend verkürzen.



ALLARME:
TEMPERATURA ELEVATA

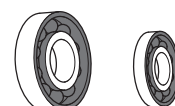
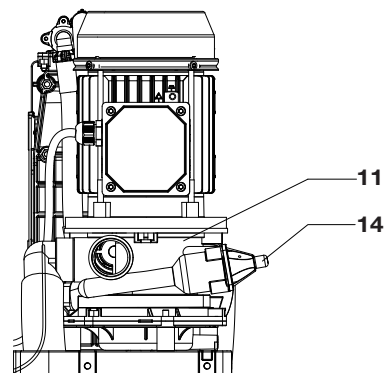
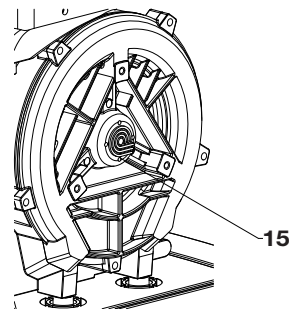

• Anleitung zum Steuern der Micro-Smart Menüs und zum Abändern von Parametern

Hauptmenüs

Wenn der Micro-Smart angeschaltet wird, zeigt das Display für 10 Sekunden das CATTANI-Logo. Danach erscheint das Hauptmenü.



Hauptmenü "A1"

Dieses Menü zeigt einige Parameter wie: Geschwindigkeit des Saugmotors, Absaugaktivierungszeit, Temperatur, Abwesenheit des Amalgambehälters und Systemsoftwareversion.

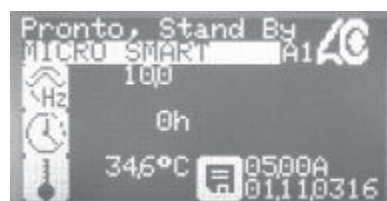

drücken, um in das Systemmenü "A2" zu gelangen

Systemmenü "A2"

Das Display zeigt die Anzahl der Male, die der Micro-Smart mit dem Hauptschalter angeschaltet wurde (Power Cycles), die Gesamtzeit, die der Micro-Smart mit Strom versorgt wurde (Uptime), die Anzahl der Male, die die Absaugung aktiviert wurde (Work Cycles), die Gesamtbetriebsstunden des Absauggerätes (Work Time), die Gesamtbetriebsstunden in Zusammenhang mit der Frequenz (HZ) und die Anzahl der Male, die der Lüfter zur Kühlung der Elektronik aktiviert wurde (Fan Cycles).

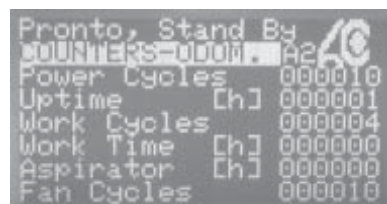

Pfeil nach rechts

Ereignismenü "A3"

Das Menü zeigt die letzten Ereignisse oder Alarme, die beim Micro-Smart aufgetreten sind. Ereignisse werden durch eine Zahl angezeigt; lesen Sie in der Tabelle auf Seite 95, um sie zu identifizieren.

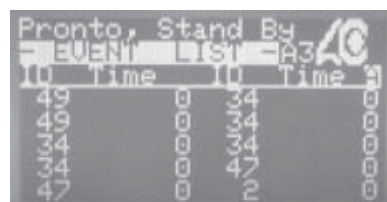



Kontrollmenü "A2"

COUNTERS – ODOM . A2		
POWER CYCLES	000000	Anzahl der Male, die das Absauggerät mit dem Hauptschalter angeschaltet wurde.
UPTIME [h]	000000	Gesamtzeit, die der Micro-Smart mit Strom versorgt wurde (ausgeschaltete Motoren).
WORK CYCLES	000000	Anzahl der Male, die das Absauggerät durch die Dentaleinheit aktiviert wurde.
WORK TIME [h]	000000	Anzahl der tatsächlichen Betriebsstunden (laufende Motoren).
ASPIRATOR [h]	000000	Gesamtbetriebsstunden in Zusammenhang mit der Frequenz (HZ).
FAN CYCLES	000000	Anzahl der Male, die der Lüfter zur Kühlung der Elektronik aktiviert wurde.

DEUTSCH

Untermenüs

 drücken, um in die Untermenüs zu gelangen.

Durch Drücken der Scroll Down Taste  gelangt man durch die anderen Menüs.

Drive Status (Betriebszustand)

Auf dieses Menü kann ohne Zugangspasswort zugegriffen werden. Das Display zeigt nützliche Informationen über den Betrieb.

User Parameters (Benutzerparameter)

Das Passwort 0000123000 benutzen, um in dieses Menü zu gelangen.

In diesem Menü können der Unterdruck und die Sprache im Display eingestellt werden.

System Parameters Setup (Systemparametereinstellung)

Das Passwort 0000456000 muss eingegeben werden, um Zugang zu diesem Menü zu erhalten.

In diesem Menü können die Ausschaltverzögerungszeit und andere technische Parameter eingestellt werden.

Factory Settings Restricted Access (Werkseinstellung)

Auf dieses Menü kann nicht vom Benutzer zugegriffen werden. Nur der Hersteller kann darauf zugreifen.

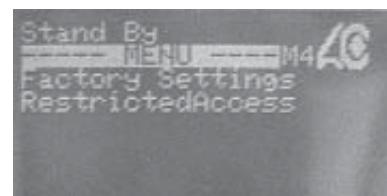
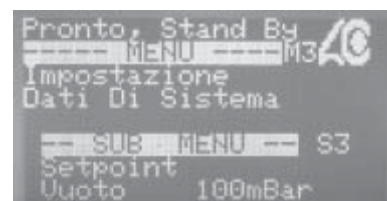
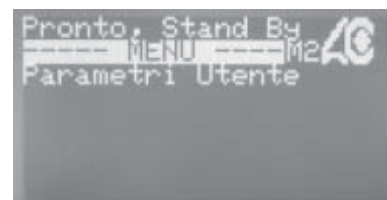
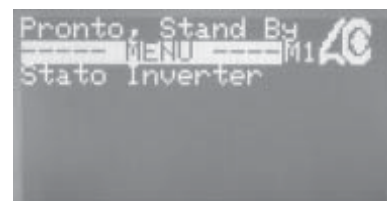
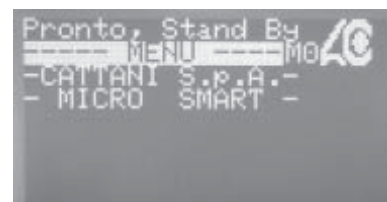
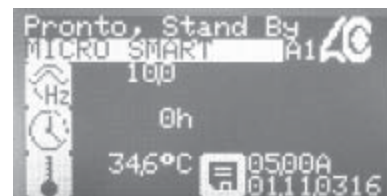

scroll down button
↓

Eingabe von Zugangspasswörtern

Das Drive Status Menu ist das einzige Menü mit Zugang ohne Passwort.

Um in die Menüs „User Parameters“ und „System Parameters Setup“ zu gelangen, muss man erst ein Zugangspasswort eingeben:

Zugangspasswort für das Menü „User Parameters“ „0000123000“.

Zugangspasswort für das Menü „System Parameters Setup“ „0000456000“.



Im „CATTANI S.p.A.“ Menü  und danach  drücken.

Das Display sollte dann „Access Password“ 0000000000 anzeigen.

Die Eingabetaste  drücken, welche einen Cursor bei der letzten Null rechts erscheinen lässt.

 solange drücken, bis der Cursor bei der 6. Null aufleuchtet.

 solange drücken, bis die Zahl 1 erscheint.

 drücken, um zu der nächsten Null zu gelangen, 

dann  solange drücken, bis die Zahl 2 erscheint.

 drücken, um zu der nächsten Null zu gelangen, dann solange drücken, bis die Zahl 3 erscheint.

Die Eingabetaste  drücken, um das Passwort zu bestätigen. Der Cursor verschwindet.

 drücken, um zum Menü „Cattani S.p.A.“ zurückzukehren.

Es ist nun möglich, die Parameter des Menüs „User Parameters“ abzuändern.

Den Prozess wiederholen und das Passwort 0000456000 eingeben, um Zugang zum Menü „System Parameters Setup“ zu erhalten.

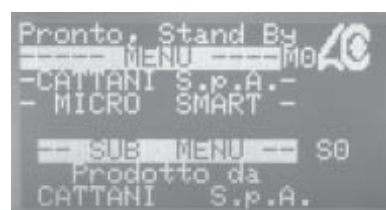
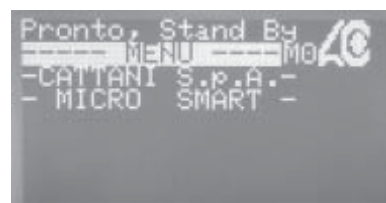

Drive Status (Betriebszustand)

Auf dieses Menü kann ohne Passwort zugegriffen werden. Es zeigt verschiedene technische Parameter bezüglich der Echtzeit-Arbeitungsbedingungen des Micro-Smarts. Unten aufgelistet sind weitere allgemein benötigte Informationen.

Blower Output Frequency (Arbeitsfrequenz des Absaugmotors) (max. Einstellung: 120 Hz)

Blower Output Voltage (Spannung des Absaugmotors) (max. Einstellung: 220V)

Blower Overall Current (Strom des Absaugmotors) (max. Einstellung: 4,3 A)

Pump (Centrifuge) Output Frequency (Arbeitsfrequenz des Zentrifugalabscheiders) (festgelegte Einstellung: 75 Hz)

Pump (Centrifuge) Output Voltage (Spannung des Zentrifugalabscheiders) (max. Einstellung: 220V)

Pump (Centrifuge) Overall Bus Current (Vom Zentrifugalabscheider aufgenommener Strom) (max. Einstellung: 3,2 A)

scroll down button

```
Pronto, Stand By
----- MENU ----- M1
Stato Inverter
```

```
Pronto, Stand By
----- MENU ----- M1
Stato Inverter

-- SUB MENU -- S0
FrequenzaAttuale
Soffiante 0100Hz
```

```
Pronto, Stand By
----- MENU ----- M1
Stato Inverter

-- SUB MENU -- S1
Tensione Uscita
Soffiante 029[V]
```

```
Pronto, Stand By
----- MENU ----- M1
Stato Inverter

-- SUB MENU -- S2
Corrente
Soffiante 000A
```

```
Pronto, Stand By
----- MENU ----- M1
Stato Inverter

-- SUB MENU -- S3
Frequenza Uscita
Centrifuga 100Hz
```

```
Pronto, Stand By
----- MENU ----- M1
Stato Inverter

-- SUB MENU -- S4
Tensione Uscita
Centrifuga037[V]
```

```
Pronto, Stand By
----- MENU ----- M1
Stato Inverter

-- SUB MENU -- S5
Corrente
Centrifuga 000A
```

System Temperature (Temperatur des Systems)

Maximum Detected Temperature (Max. gespeicherte Temperatur) (+60 °C: Alarm und Stopp des Absauggerätes, zurücksetzbarer Wert)

Maximum Detected Temperature (Max. gespeicherte Temperatur) (+60 °C: Temperaturspeicher, nicht zurücksetzbarer Wert)

Power Bus Voltage (Gleichrichterspannung) (max. Einstellung: 390V)

Max. Detected Power Bus Voltage (Max. U Gleichrichter) (max. Einstellung: 390V)

Power Bus Ripple (Oberwellenspannung)

Vacuum Set Point (Unterdruckeinstellung) (max. Einstellung: 210 mbar)

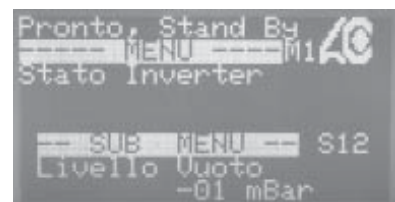
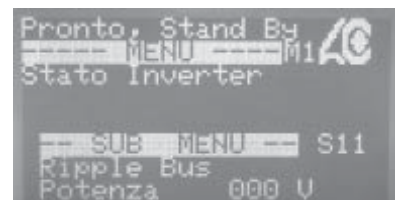
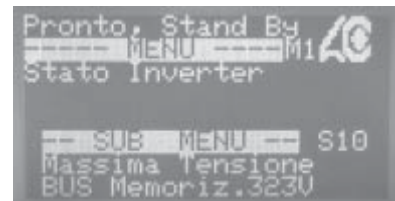
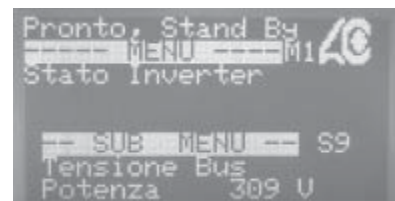
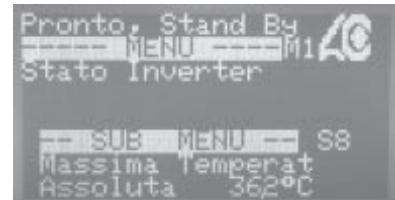
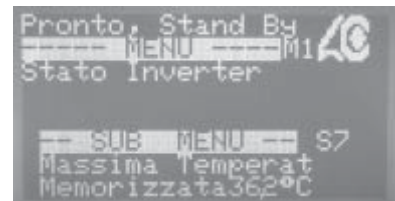
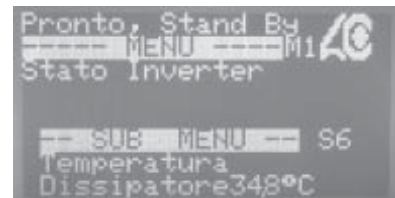

scroll down button

DEUTSCH



Run mode (Arbeitsmodus: Beschreibung des Arbeitsmodus der Maschine)

User Parameters menu (Menü Benutzerparameter)

Um Zugang zu diesem Menü zu bekommen, muss man das Zugangspasswort 0000123000 eingeben (siehe Anweisungen auf Seite 83).

Vacuum Set Point (Unterdruckeinstellung)



Dies ist der Wert, bis zu dem die Einheit den Druck beschränkt.

Die Eingabetaste  drücken, um den Cursor erscheinen zu lassen. Der Wert kann durch den Gebrauch der Pfeiltasten   verändert werden.

Die Eingabetaste  erneut drücken, um zu bestätigen.

Language (Sprache)

Es ist möglich, entweder Englisch (1) oder Italienisch (0), Französisch (2), Deutsch (3), als Sprache im Display zu wählen.

Die Eingabetaste  drücken, um den Cursor zu aktivieren und die Pfeiltasten   benutzen, um 0 oder 1 oder 2 oder 3 zu wählen.

Die Eingabetaste  erneut drücken, um die Änderung zu bestätigen.

Generated Code (Herstellercode)

Dieser Code wird von der Cattani S.p.A. erzeugt. Jeder Einheit ist ein einziger Code zugeordnet. Dieser Code ist derzeit nicht benutzbar.

Activation Code (Aktivierungskode)

Dieser Code ist derzeit nicht benutzbar.

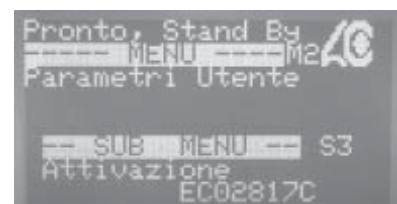
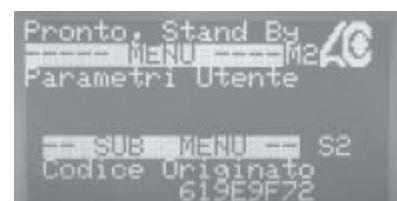
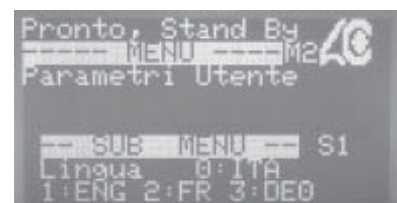
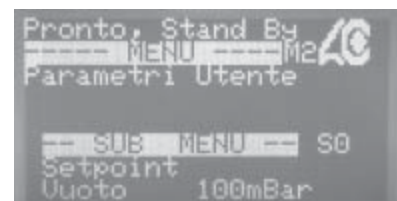
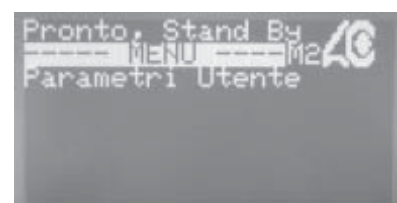
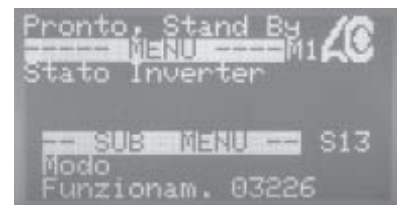



scroll down button

System Parameters Setup menu (Menü Systemparametereinstellung)

Um Zugang zu diesem Menü zu bekommen und/ oder Änderungen vorzunehmen, muss man das Passwort 0000456000 eingeben (siehe Anweisungen auf Seite 83).

Um Parameter in diesem Menü abzuändern:

Mit  scrollen, um das benötigte Parameter im Display anzuzeigen.

Die Eingabetaste  drücken, um den Cursor zu aktivieren. Der Wert kann durch Benutzen der Pfeiltasten  verändert werden.

Sobald der Wert wie gewünscht eingestellt ist, die Eingabetaste  erneut drücken, um zu bestätigen und fortzufahren.

Alle Parameter können verändert werden.

Min. Vacuum Setting (Mindestunterdruckeinstellung)

Max. Blower Output Frequency (Max. Arbeitsfrequenz des Absaugmotors bei der Mindestunterdruckeinstellung)

Blower Current limit at the Min. Setting (Max. I. des Absaugmotors bei der Mindestunterdruckeinstellung)

Medium Vacuum Level (Mittlere Unterdruckeinstellung)

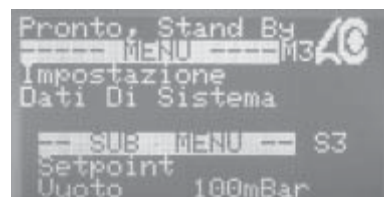
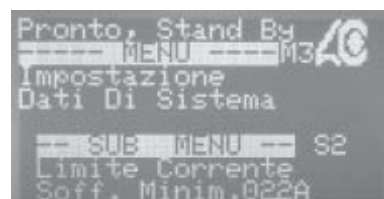
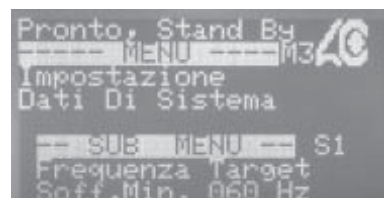
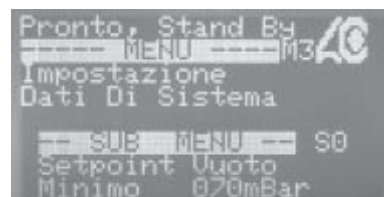

scroll down button

Max. Blower Output Frequency at the Medium Setting
(Max. Arbeitsfrequenz des Absaugmotors bei der mittleren
Unterdruckeinstellung)

Blower Current limit at the Medium Setting (Max. I. des Ab-
saugmotors bei der mittleren Einstellung)

Surgery Vacuum Setting (Chirurgische Unterdruckeinstel-
lung)

Max. Blower Output Frequency at the Surgical Setting
(Max. Arbeitsfrequenz des Absaugmotors bei der chirurgi-
schen Unterdruckeinstellung)

Blower Current limit at the Surgical Setting (Max. I. des Ab-
saugmotors bei der chirurgischen Unterdruckeinstellung)

Off Delay Time (Abschaltverzögerung) (Max. Einstellung:
300")

Pump Off Delay Time (Abschaltverzögerung des Zentrifu-
galabscheiders) (Max. Einstellung: 30")

```
Pronto, Stand By
----- MENU ----- M3 AC
Impostazione
Dati Di Sistema

--- SUB MENU --- S4
Frequenza Target
Soffiante 085 Hz
```

```
Pronto, Stand By
----- MENU ----- M3 AC
Impostazione
Dati Di Sistema

--- SUB MENU --- S5
Limite Corrente
Soffiante 025A
```

```
Pronto, Stand By
----- MENU ----- M3 AC
Impostazione
Dati Di Sistema

--- SUB MENU --- S6
Setpoint Vuoto
Chirurg. 210mBar
```

```
Pronto, Stand By
----- MENU ----- M3 AC
Impostazione
Dati Di Sistema

--- SUB MENU --- S7
Frequenza Target
Chirurgica100 Hz
```

```
Pronto, Stand By
----- MENU ----- M3 AC
Impostazione
Dati Di Sistema

--- SUB MENU --- S8
Limite Corrente
Soff. Chir. 035A
```

```
Pronto, Stand By
----- MENU ----- M3 AC
Impostazione
Dati Di Sistema

--- SUB MENU --- S9
Ritardo
Spegnim. 010s
```

```
Pronto, Stand By
----- MENU ----- M3 AC
Impostazione
Dati Di Sistema

--- SUB MENU --- S10
Ritardo Spegnim.
Pompa 05000t
```

↓
Scroll down button

Blower Off Delay Time (Abschaltverzögerung des Lüfters)
(Max. Einstellung: 300')

Running Options (Systemeinstellungskode)

Diese Option aktiviert oder deaktiviert den Amalgam-
standsensoren.

Einstellung auf 0: ohne Amalgamabscheider

Einstellung auf 2: mit Amalgamabscheider

Drive Commands (Systemkalibrierung)

Nur Werksbenutzung.

Modbusadresse

Dieses Menü wird zurzeit nicht genutzt.

Network address

Eingabe der Netzwerkadresse des Micro Smart für die Zig-
Bee Darstellung.

Zig-Bee Minimum Channel

Auswahl des Minimumkanals, auf dem der Micro Smart
kommunizieren soll.

Zig-Bee Maximum Channel

Auswahl des Maximumkanals, auf dem der Micro Smart
kommunizieren soll.

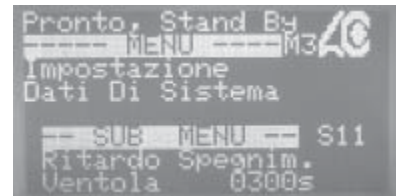

```
Pronto, Stand By
----- MENU -----M3
Impostazione
Dati Di Sistema

-- SUB MENU -- S11
Ritardo Spegnim.
Ventola 0300s
```

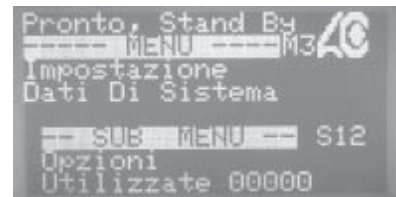

```
Pronto, Stand By
----- MENU -----M3
Impostazione
Dati Di Sistema

-- SUB MENU -- S12
Opzioni
Utilizzate 00000
```

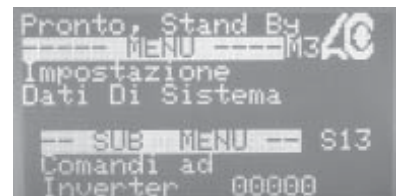

```
Pronto, Stand By
----- MENU -----M3
Impostazione
Dati Di Sistema

-- SUB MENU -- S13
Comandi ad
Inverter 00000
```

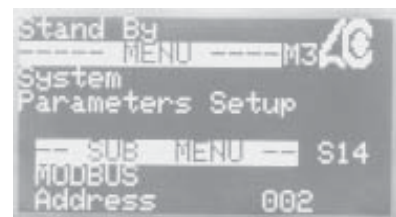

```
Stand By
----- MENU -----M3
System
Parameters Setup

-- SUB MENU -- S14
MODBUS
Address 002
```



```
Stand By
----- MENU -----M3
System
Parameters Setup

-- SUB MENU -- S15
Network
Address 104
```

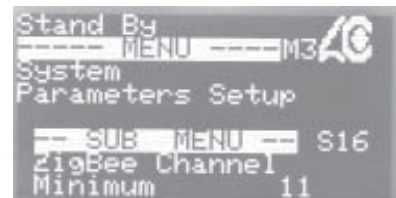

```
Stand By
----- MENU -----M3
System
Parameters Setup

-- SUB MENU -- S16
zigBee Channel
Minimum 11
```

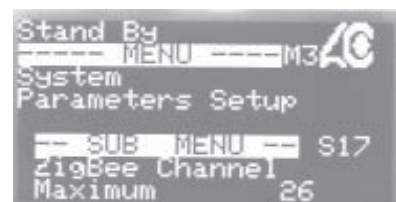

```
Stand By
----- MENU -----M3
System
Parameters Setup

-- SUB MENU -- S17
zigBee Channel
Maximum 26
```

Scroll down button

- *Anweisungen für das Einstellen der Zig-Bee-Kommunikation (drahtlos)*

Die Netzwerkadresse der Maschine einrichten.
(min. 100)
(max. 110).

Den Zig-Bee Kommunikationsschlüssel (ETRX2USB) in eine USB-Verbindung des Praxiscomputers eingeben und das Visualisierungsprogramm starten.

Das von CATTANI S.p.A. zur Verfügung gestellte Programm „Smart System Monitor“ installieren.

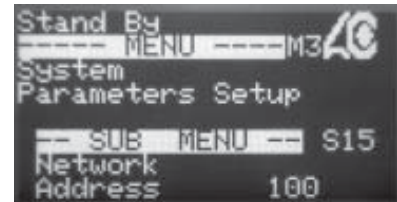

Sobald das Programm einmal gestartet wurde, wird das Hauptfirmenbild für ungefähr 10 Sekunden angezeigt, danach erscheint das Hauptmenü.



Auf das Menü „SERVICE“ klicken, um die Maschinensuchseite zu öffnen.



Auf die Schaltfläche „Verfügbare Geräte suchen“ klicken. Das Programm startet eine Suche, welche einige Sekunden dauern kann. Sobald die Suche beendet ist, zeigt das Programm die verschiedenen verfügbaren Geräte und ihren entsprechenden generatedcode an. Anmerkung: Es kann notwendig sein, diesen Prozess mehrere Male zu wiederholen.

Nachdem die verfügbaren Geräte gefunden wurden, auf die Homepage zurückkehren, um die Parameter anzuschauen.

Mit dem Aufklappmenü auswählen, welchen Micro Smart man ansehen möchte.

Es ist nun möglich, die Betriebsparameter anzusehen.

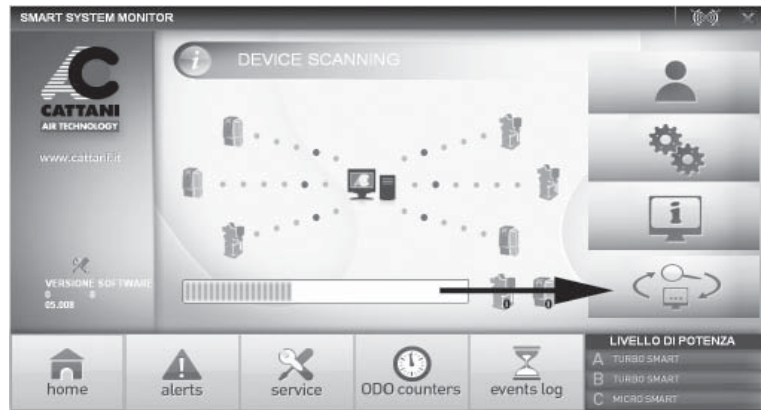

Durch Klicken auf die Schaltfläche „SERVICE“ hat man Zugang zu drei verschiedenen Menüs, von denen eines offen ist und die anderen zwei durch Passwörter eingeschränkt sind.

Um das Menü „BENUTZERPARAMETER“ zu öffnen, das Passwort 123000 eingeben und „OK“ drücken.

Durch dieses Menü kann man die Sprache und den gewünschten Unterdruck einstellen.

Um das Menü „SYSTEMPARAMETER EINSTELLUNG“ zu öffnen, das Passwort 456000 eingeben und „OK“ drücken.



In diesem Menü kann man alle Parameter ansehen und abändern.

Das Menü „INVERTERSTATUS“ erfordert kein Passwort für den Zugang. Dieses Menü zeigt die funktionalen Parameter der Maschine, während sie in Betrieb ist.

Vom Hauptmenü aus auf die Schaltfläche „E-MAIL“ klicken, um die Einzelheiten des Technikers oder Arztes einzugeben, zu dem Alarmsignale geschickt werden sollen.

Bei Betriebsstörungen wird ein Alarm auf dem Bildschirm angezeigt und eine E-Mail an den eingegebenen Kontakt geschickt (wie oben erwähnt).

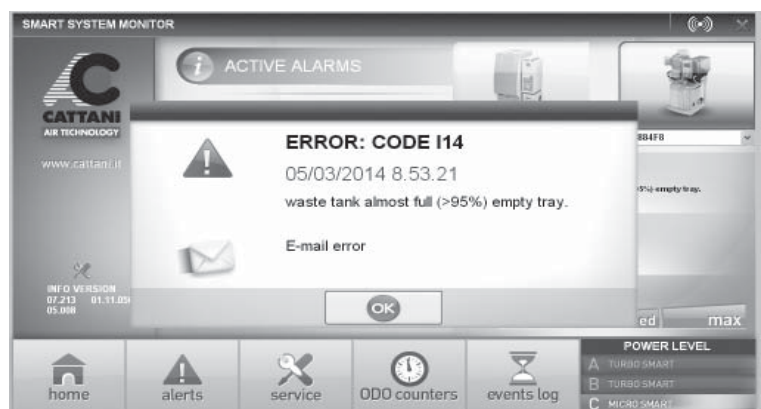
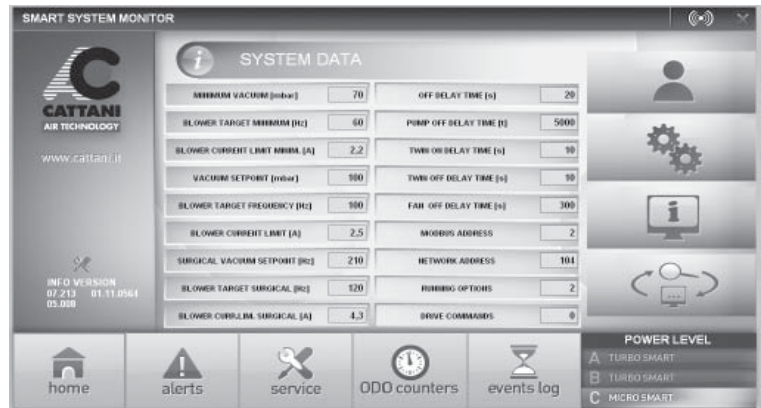

Jeder Alarm, der an einem Tag entstanden ist, wird mit einem Fehlercode und Beschreibung in der Schaltfläche „ALARME“ angezeigt.

Die komplette Alarmhistorie, die während der Betriebszeit aufgezeichnet wurde, kann unter „EVENTS LOG“ angeschaut werden.

Die Arbeitsgänge werden aufgezeichnet und können unter „ODO COUNTERS“ angesehen werden.

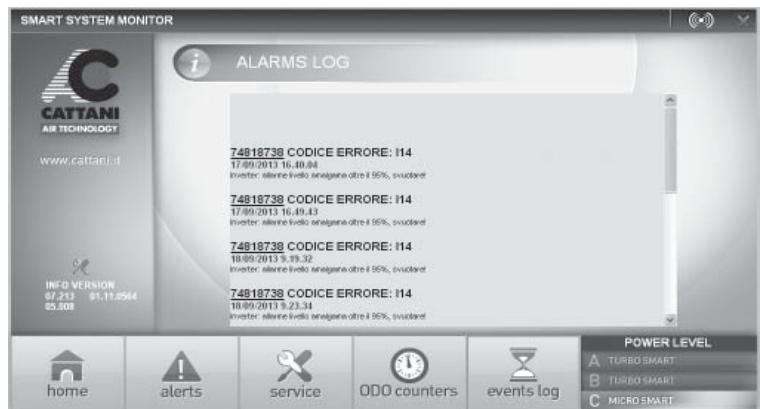
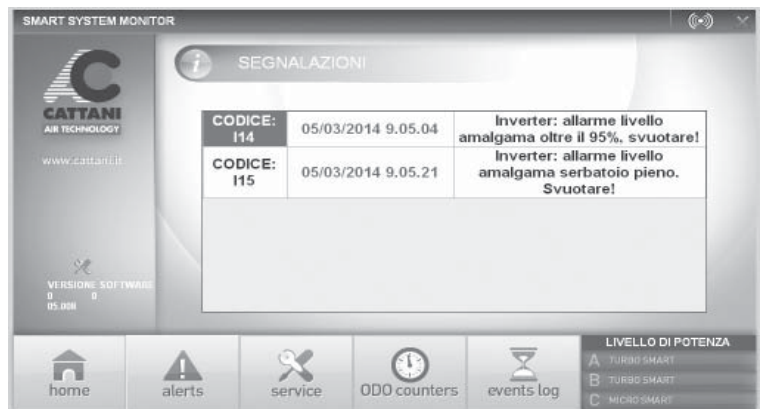

• Alarmbeschreibung

Alarm-code AC100	BESCHREIBUNG	LÖSUNG
0	Microcontroller-Erinnerungsalarm	Den Techniker kontaktieren
32	Microcontroller-Erinnerungsalarm	Den Techniker kontaktieren
33	Kurzschluss an einem der beiden Motoren	Prüfen, woher der Kurzschluss kommt, und ihn beseitigen
34	Kurzschluss, bevor die Motoren starten	Den Techniker kontaktieren (die Platine ist wahrscheinlich beschädigt)
35	Die Kondensatoren wurden nicht geladen.	Den Techniker kontaktieren (die Platine ersetzen)
36	Übertemperatur (die Temperatur hat die max. erlaubte Grenze überschritten)	Den Maschinenraum lüften.
37	Überstrom des Gebläses (das Gebläse hat die max. Stromgrenze überschritten)	Den Betrieb der Turbine überprüfen (Stillstand oder übermäßige Reibung)
39	Überspannung der Kondensatoren (die Kondensatoren haben die max. Spannungsgrenze überschritten)	Die Netzspannung kontrollieren (max. 260V)
40	Zentrifuge Kurzschluss	Den Kurzschluss beseitigen
41	Platine Kurzschluss am Zentrifugenausgang	Die Platine ersetzen
42	Sofortiger Überstrom der Zentrifuge (die Zentrifuge hat die Stromgrenze überschritten)	Den Abfluss und den Betrieb der Zentrifuge kontrollieren (Stillstand oder übermäßige Reibung)
43	Zeitverzögerter Überstrom der Zentrifuge (die Zentrifuge hat die Stromgrenze überschritten)	Den Abfluss und den Betrieb der Zentrifuge kontrollieren (Stillstand oder übermäßige Reibung)
45	Der Amalgamstandsensor ist nicht verbunden	Der Amalgamstandsensor verbinden
46	Amalgamstand > 95%	Den Amalgamsammelbehälter sobald wie möglich ersetzen
47	Amalgamstand > 100%	Den Amalgamsammelbehälter ersetzen
48	Der Vakuumsensorschlauch ist nicht verbunden	Den Vakuumsensorschlauch mit der Zentrifuge verbinden
49	Thermischer Schutzschalter abgeschaltet	Die Temperatur im Maschinenraum überprüfen

- *Wichtige Hinweise*
- *Transport und Lagerung*
- *Transport von Gebrauchtgerten*

• **Wichtige Hinweise**

- Auf die Geräte wird eine einjährige Garantie gewährt, die ab dem Verkaufsdatum einsetzt. Um Anrecht auf die Garantie zu erhalten, muss dem Hersteller der entsprechende Garantieschein unter Angabe des Kaufdatums, des Verkäufers und des Verwenders zurückgesendet werden.
- Die Garantie und die Haftung des Herstellers verfallen, wenn die Geräte mit ungeeigneten oder von den angegebenen Produkten abweichenden Produkten behandelt werden oder durch Eingriffe jeglicher Art seitens nicht vom Hersteller autorisierter Personen verändert werden.
- Der Hersteller, die Vertragshändler, die Vertreter und autorisierten Techniker stehen gerne für die Lieferung von Ersatzteilen, Unterlagen, Anleitungen und anderen nützlichen Informationen zur Verfügung.
- Der Hersteller behält sich das Recht ohne Vorankündigung auf Abänderungen der von ihm hergestellten Produkte vor, wenn technische Anforderungen, Produktverbesserungen, Zulassungs- und Betriebsschwierigkeiten sowie die Verfügbarkeit von Produkten und Ersatzteilen es erfordern.
- Auf der Internetseite www.cattani.it finden Sie unsere aktualisierten Handbücher. Wir empfehlen, diese Handbücher und insbesondere die Aktualisierungen betreffend Sicherheit zu lesen.
- Der Micro-Smart ist ein Elektrogerät, daher unterliegt er dem Elektro- und Elektronikgerätegesetz (ElektroG)/ WEEE-Richtlinie.

• **Transport und Lagerung**

- Beim Transport und bei der Lagerung können die verpackten Ausrüstungen Temperaturen zwischen - 10 °C und + 60 °C ausgesetzt werden.
- Die Kolli dürfen keinem Wasser und Wasserstrahl und keiner Feuchtigkeit über 70% ausgesetzt werden.
- Es können jeweils nur drei Kolli mit dem gleichen Gewicht gestapelt werden.

• **Transport von Gebrauchtgerten**

- Bevor das Geräte verpackt wird, raten wir es mit Fast & Steril 3 (siehe Abschnitt "Signale und Hinweise" und "Ordentliche Wartung") zu reinigen und desinfizieren.
- Alle Schläuche und Öffnungen (einschließlich der, die Flüssigkeit aus dem Inneren der Maschine transportieren) entleeren und mögliche Restflüssigkeiten (einschließlich Desinfektionsmittel) ablaufen lassen, die die Steuertafel beschädigen können. Den Amalgamsammelbehälter entfernen, das Desinfektionsmittel hinzufügen, den Deckel auf dem Behälter platzieren und hermetisch verschließen. Sobald die Saugmaschine trocken ist – jeweils außen und innen – alle Ein- und Auslässe mit den zweckgebundenen Deckeln verschließen, einen neuen (und leeren) Amalgamsammelbehälter in das Gerät einsetzen, sowohl die Saugmaschine als auch die Steuertafel jeweils einzeln in Kunststoffolie einwickeln, um sicherzustellen, dass diese Teile restwassergeschützt sind.
- Das Gerät in einen Polyäthylenbeutel schließen und in einer dreischichtigen Wellpappe verpacken.



MICRO SMART



SUSTAINABLE PROGRESS

INDICE

Datos generales de funcionamiento aspirador para usos dentales Micro-Smart.....	98
Introducción	99
Señales y avisos	99
Montaje y puesta en funcionamiento	100
Mantenimiento ordinario	103
Mantenimiento extraordinario	104
Instrucciones para moverse y modificar algunos parámetros en los menús	105
Instrucciones para configurar la comunicación inalámbrica Zig-bee (wireless).....	114
Descripciones de alarmas	119
Avisos importantes	120
Transporte y almacenamiento	120
Transporte de los aparatos usados	120
Ilustración	121

- *Datos generales de funcionamiento aspirador para usos dentales Micro-Smart*

Modelo	Micro-Smart
Tensión nominal	230 V \sim
Frecuencia nominal	50/60 Hz
Corriente nominal	6,3 A
Tipo de protección contra los contactos directos o indirectos	Clase I
Modalidad de empleo	Funcionamiento continuo
Protección contra la humedad	Común
Grado de protección contra los contactos directos o indirectos	Tipo B
Potencia máxima absorbida	1,30 kW
Caudal máximo	55 m ³ /h
Presión máxima de trabajo para el servicio continuo	2100 mm H ₂ O
Presión sonora versión no carenada de 60Hz a 120Hz	de 64 dB(A) a 71 dB(A)
Presión sonora grupo aspirante versión carenada en plástico da 60Hz a 120Hz	de 63 dB(A) a 68,5 dB(A)
Presión sonora versión carenada para interiores de 60Hz a 120Hz	de 41 dB(A) a 48 dB(A)
Presión sonora versión carenada para exterior de 60Hz a 120Hz	de 54,5 dB(A) a 61,2 dB(A)

\sim	Corriente alterna	IEC 417-5032
	Toma de tierra (de funcionamiento)	IEC 417-5019
	Grado de protección contra los contactos directos o indirectos	CEI EN 60601-1
	Abierto (desconexión de la red de alimentación)	IEC 417-5008
I	Cerrado (conexión a la red de alimentación)	IEC 417-5007

Nivel de presión sonora detectado según la norma ISO 3746-1979 (E).
 Párametros: r = 1,5 - ruido de fondo: 34 dB (A) - instrumento: Brüel & Kjær type 2232.

- *Introducción*
- *Señales y avisos*

- **Introducción**

La siguiente presentación tiene como objetivo de ilustrar el montaje y la puesta en funcionamiento y también informar acerca de los peligros y precauciones útiles para la prevención.

Este manual debe estar siempre disponible para ser consultado durante el montaje, la puesta en funcionamiento, el uso y el mantenimiento del Micro-Smart.

En el sitio de Internet **www.cattani.it** pueden encontrarse nuestros manuales **actualizados**.

Recomendamos su consulta especialmente para las actualizaciones sobre la **seguridad**.

- **Señales y avisos**

- *Peligro de sacudidas eléctricas, incluso la de 230 V \sim puede resultar mortal.*



- *Peligro biológico, infecciones de enfermedades epidémicas.*



- *Señal genérica de peligro.*



- *Protecciones personales para trabajos pesados.*



- *Protecciones personales para peligro biológico.*



- *Alta temperatura.*



- *Local aislado de sustancias inflamables, corrosivas o explosivas.*



- *Dirección obligatoria del flujo o del sentido de rotación.*



No siempre resulta posible expresar con una señal los avisos de peligro, por ello es necesario que el usuario lea los avisos y los tenga en cuenta convenientemente.

No respetar una señal o un aviso de peligro puede causar daños al operador o al paciente.

No retirar las protecciones para la prevención de accidentes, no modificar las máquinas o su funcionamiento.

A pesar de todo nuestro empeño, es posible que los avisos de peligro no sean exhaustivos; solicitamos la colaboración del usuario, rogándole al mismo tiempo que se encargue él mismo de prever las fuentes de peligro que tal vez no hemos tenido en cuenta y que nos las comunique.

• Montaje y puesta en funcionamiento

• Precauciones recomendadas

Antes de desembalar el aparato, comprobar el exterior del embalaje, poner atención al indicador de daños, si el indicador está rojo, o el cartón dañado, aceptarlo con reserva de controlar el aparato.

Desembalar la máquina siguiendo las instrucciones representadas en el mismo embalaje. El cartón es reciclable, si aconseja disponerlo para tal fin respetando las normas vigentes. Conservar las tapas que cierran todas las comunicaciones exterior/interior del equipo, ya que se podrán utilizar para mover el aspirador de sitio.

El montaje de la máquina debe ser efectuado por una persona experta y equipada. El aspirador debe ser colocado en un lugar limpio, lejos de fuentes de calor, de la humedad y del polvo. En las instalaciones externas: balcones, terrazas o jardines, proteger las máquinas de la lluvia, de la suciedad, del hielo y de la exposición directa a los rayos del sol.

Les recomendamos en éstos casos el carenado para exteriores del Micro-Smart completo de: doble techo aislante, sistema antihielo y sistema de ventilación, suministrado con termostato fijo para la regulación automática de la temperatura.

La temperatura ambiente del local técnico no debe ser inferior a los + 5 °C y no debe ser superior a los + 35 °C.

Las máquinas carenadas, para interior y exterior, pueden ser pedidas completas de instalación antihielo. Donde fuera necesario ventilar o acondicionar la sala de máquinas, es aconsejable hacer proyectar una instalación de ventilación o de acondicionamiento por parte de un especialista. El local técnico no debe ser accesible para pacientes o personal no autorizado. Cuando no se disponga de dicho local, es necesario que las máquinas estén protegidas por un adecuado carenado, no fácilmente retirable. Utilizar protecciones y carteles indicadores de peligro, a fin de evitar contactos accidentales peligrosos por las sacudidas eléctricas y por la posibilidad (remota pero no excluible) de incendio, de explosión o por el escape de aire y líquidos contaminantes. Utilizar exclusivamente carenados (para exteriores e interiores) estudiados y construidos por el fabricante de las mismas máquinas.

En el local tecnológico no debe haber material inflamable, verificar que no exista la posibilidad de fugas de gas. No conectar a la red eléctrica aparatos dañados, no utilizar cordón de extensión, tomas o enchufes múltiples. Antes de conectar el aparato a la línea de alimentación, verificar que ésta es conforme a las normas CEI 64-8 y que esté presente un interruptor magnetotérmico y un interruptor diferencial (clase A o B) (16A) según las normas EN 61008-1.

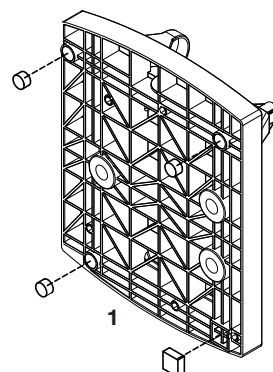
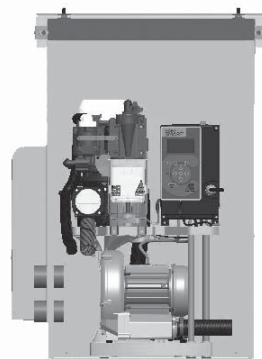
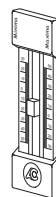
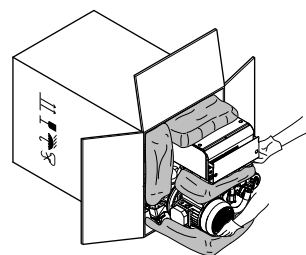

Los pavimentos de color claro, de madera, linóleo, goma o mármol, en contacto con los antivibrantes de goma (1), pueden cambiar de color o quedar marcados por sombras más oscuras. Aislar por tanto los antivibrantes del suelo con un hoja de plástico o de otro producto adecuado para tal fin.

• **Montaje**

Antes de conectar el aspirador a la canalización de la instalación centralizada, asegurarse de que las tuberías aspirantes estén limpias; los residuos pesados podrían dañar el aparato.

El tubo de aspiración en PVC (3) de color gris claro en dotación con el aparato debe ser conectado al portatubo (2) diámetro 30 mm “entrada líquido aspirado”. Por la parte opuesta el mismo tubo se conectará a la canalización aspirante (2b) que llega de las clínicas dentales.

El tubo para el aire expulsado (4b) (de color negro, resistente a la temperatura, con espiral metálica) debe ser conectado al portatubo (4) diámetro 30 mm “salida aire expulsado”, el otro extremo del tubo será conectado al filtro antibacteriano (5) pasando preferiblemente a través de un silenciador (5a) siempre en dotación con el aspirador. En la salida del filtro antibacteriano, el aire expulsado todavía caliente, deberá ser canalizado al exterior.

El portatubo (6, pag. 103), diámetro 18 mm será conectado al tubo de desagüe. Hay que tener presente que, en la versión con hidrociclón, el aspirador drena por caída y que en ningún caso puede descargar hacia arriba. El portatubo (8, pag. 102) diámetro 10 mm “desagüe de emergencia” debe ser conectado al tubo de desagüe. El portatubo (6b) diámetro 11mm va conectado al tubo de desagüe cuando no hay separador de amalgama. Los tubos de conexión que unen la máquina a la instalación de aspiración y de desagüe, son flexibles para amortiguar las pequeñas vibraciones derivadas del funcionamiento del aspirador.

La canalización aspirante corre generalmente por el suelo, en proximidad del aspirador sube unos 30 cm hasta alcanzar el portatubo (2) (fig. A y B, pag. 121).

También cuando el Micro-Smart está situado en un piso inferior respecto a los gabinetes, la canalización aspirante debe descender de las clínicas al piso del aspirador, hacer un recorrido de algún metro en el piso sobre el suelo y salir con un tubo flexible hasta el separador centrífugo (fig. B, pag. 121), el fluido aspirado será reabsorbido por el aspirador.

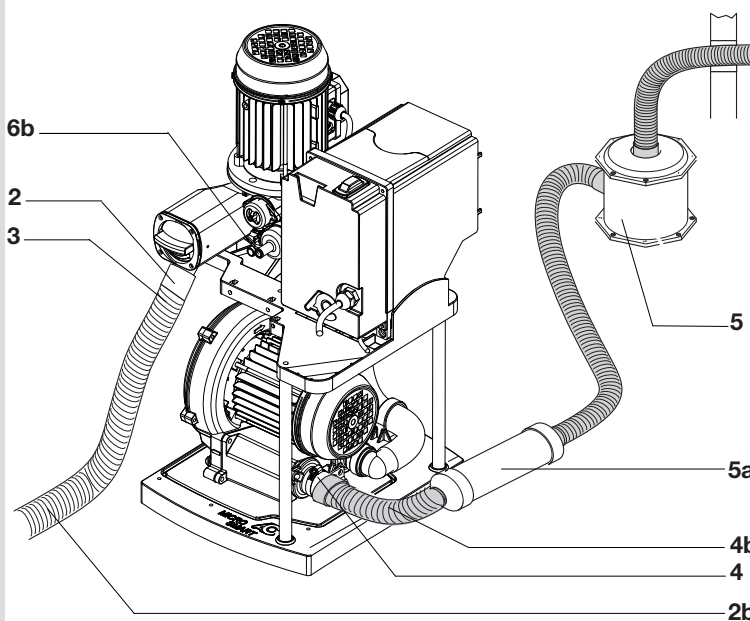
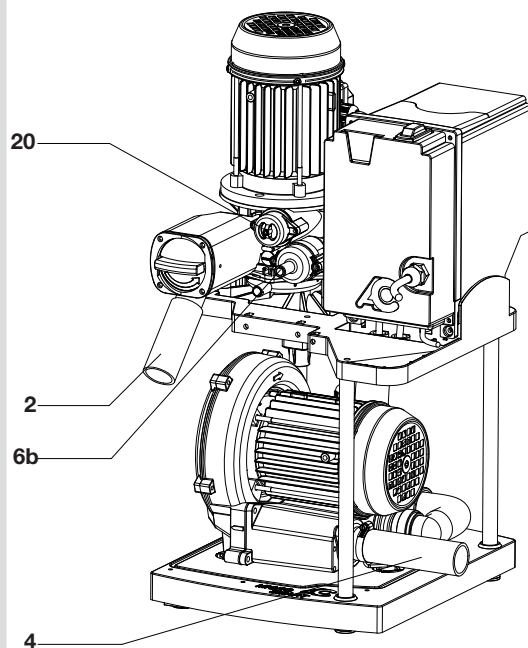

Terminado el montaje se deberá conectar el cable de alimentación a la línea eléctrica del edificio según la normativa EN 61008-1.

Por último se conectará la línea de las señales de baja tensión que une el equipo al aspirador. Asegurarse de que se trata de un contacto limpio (sin tensión).

- **Puesta en funcionamiento, comprobación e instrucción del personal.**

Una vez montado y conectado el aspirador, bastará apretar el botón encendido/apagado y hacer partir la señal de uno de los equipos conectados, para que se produzca el arranque del aspirador.

Para verificar el correcto funcionamiento del aspirador Micro-Smart, es aconsejable efectuar los test de tipo dinámico (ver fig. E, pag. 124) y consultar el diagrama de trabajo del Micro-Smart, fig. F pag. 125.

Las instrucciones del personal para el uso y el mantenimiento ordinarios del aspirador, se hacen con el aparato nuevo aún no contaminado.

El personal de la clínica debe ser instruido para seguir en el display las fases de funcionamiento del Micro-Smart, a interpretar avisos de peligro y hacer una correcta mantenimiento con Puli-Jet plus new (A) y Pulse Cleaner (B) y a usar regularmente las pastillas antiespumógenas (C).

- **Funcionamiento**

El grupo aspirante (9) (a través del tubo 10) crea la depresión en el separador centrífugo (11). El fluido proveniente de los equipos, a través del tubo colector (2) entra en el separador centrífugo (11).

El separador centrífugo separa el aire de los líquidos: el aire es expulsado al exterior a través del tubo (4) mientras los líquidos son enviados al desagüe a través del tubo de descarga conectado al portatubo (6b) en ausencia del separador de amalgama y al portatubo (6) en presencia del separador de amalgama.

La puesta en marcha del separador centrífugo (11) es anticipada con respecto a la turbina (9), por lo tanto permite expulsar líquidos acumulados eventualmente en el separador centrífugo, antes de que haya arrancado el aspirador. Además, cuando se apaga la máquina, un temporizador regulable mantendrá funcionando el aspirador de 10 a 120 segundos.

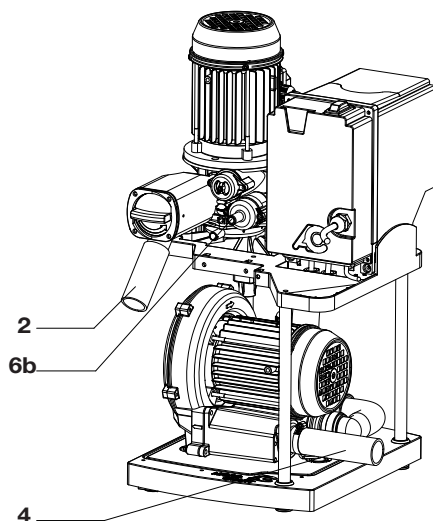
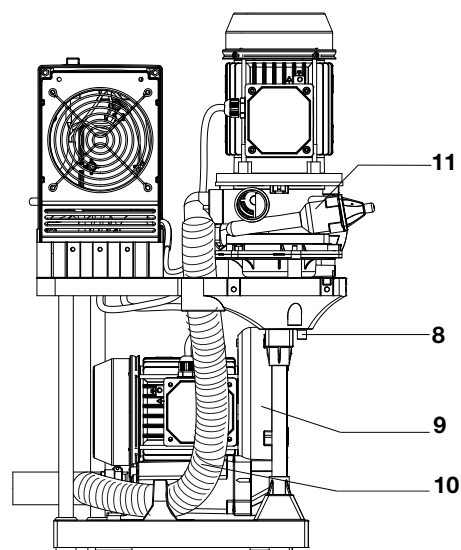
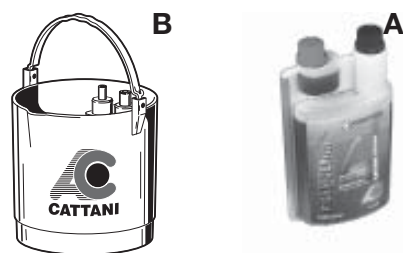

• *Mantenimiento ordinario*

• *El separador de amalgama ISO según las normas ISO 11143*

El Micro-Smart puede ser pedido con separador de amalgama "Hidrociclón ISO 5,5 l/min." (el separador de amalgama va siempre acompañado del manual de instrucciones y manutención).

El mantenimiento ordinario debe ser efectuado por el personal de la clínica expresamente instruido.

- Se recuerda poner particular atención a todas las señales de peligro y de protegerse con gafas, guantes y mascarillas monouso.

Cada día (especialmente al final de cada jornada, o más veces al día según la necesidad)

- Controlar en el display las ocasionales señalizaciones de alarmas, en presencia de avisos de peligro, llamar al técnico.
- Aspiración vespertina de la solución de Puli-Jet plus new con anticalcáreo **(A)** con Pulse Cleaner **(B)**.
- Limpieza de los filtros de aspiración del equipo, recuperar los residuos según las normativas vigentes, especialmente si se trata d amalgama, y colocar las pastillas de antiespumógeno desinfectante **(C)** en los filtros.
- **Antes de llevar a cabo cualquier intervención en la máquina, quitar la corriente.**
- Limpiar el filtro del aspirador.

Ocasionalmente según las necesidades

- Controlar que no se formen obstáculos para la libre ventilación del aspirador.
- Mantener libre el local tecnológico de todo aquello que no atañe a las mismas máquinas, con especial referencia a material infl amable. Vigilar que no se dè la posibilidad de formación de mezclas corrosivas, infl amables y explosivas.



ALLARME:
TEMPERATURA ELEVATA

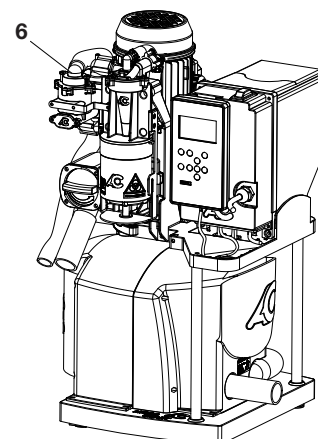
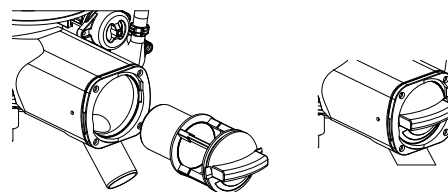
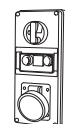
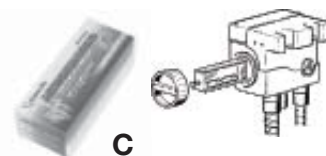
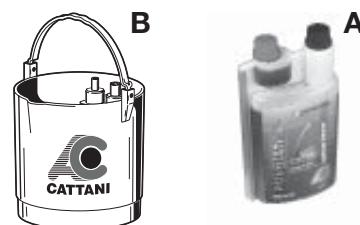

• *Mantenimiento extraordinario*

El mantenimiento extraordinario debe ser confiado a un técnico preparado dotado de repuestos originales.

- Poner particular atención a todas las señales de peligro y protegerse con gafas, guantes y mascarillas monouso.
- Controlar el estado de mantenimiento ordinario; verificar que se usen productos Magnolia.
- Antes de intervenir sobre los aparatos, hacer algunos lavados con Fast&Steril 3 (D), esperar 15 min. hasta que la acción desinfectante haya hecho su efecto.

Controles aconsejados cada 12 meses *

- Controlar las temperaturas máximas registradas y todas las señales de alarma, intervenir en consecuencia.
- Constatando precariedad de mantenimiento ordinario o en el caso de que sean usados productos impropios, instruir al personal e informar al responsable de la clínica. La garantía caduca cuando los aparatos son tratados con productos distintos de los indicados.
- Controlar el ruido del aspirador (ver pag. 98).
- Con un chorro de aire seco que no supere la tensión de 2 bar, eliminar el polvo del ventilador y el dissipador de la central eléctrica y con un chorro de aire seco de 6 bar limpiar los orificios de la tapa delantera del motor de aspiración (15).

Controles aconsejados cada 18-24 meses

- Controlar las condiciones de los tubos de plástico, en particular de los tubos bajo presión de conexión entre el separador centrífugo (11) y el Hidrociclón ISO. Aconsejamos sustituir estos tubos cada 18-24 meses.
- Controlar las condiciones de funcionamiento del separador centrífugo (11) y de la válvula de recirculación (14).

Controles aconsejados cada 10.000/15.000 horas

- Cada vez que se desmonta un componente que contiene una parte de goma (O-Ring, junta o retén) sustituir la parte de goma.
- Sustituir los cojinetes de los motores.

(*) Los tiempos de intervención son indicativos. En presencia de trabajos con polvo o especial carga de trabajo, aumentar las intervenciones según la necesidad.

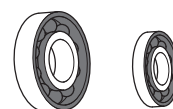
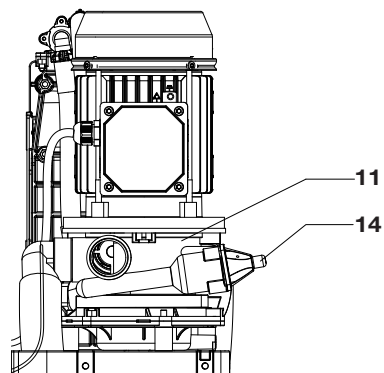
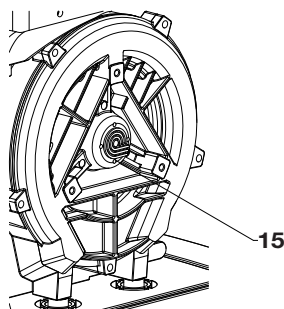
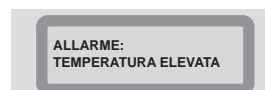

• Instrucciones para moverse y modificar algunos parámetros en los menús

Menús principales

Al encender el Micro-Smart, el display gráfico muestra por 10 segundos el logo de Cattani S.p.A., al final del cual aparecerá el menú principal.



Menú principal "A1"

Son visibles algunos parámetros como la frecuencia de ejercicio, el tiempo de activación del aspirador, la temperatura, el contenedor de amalgama (si lo lleva) y la revisión del software del sistema.

Pulsando  se accede a el

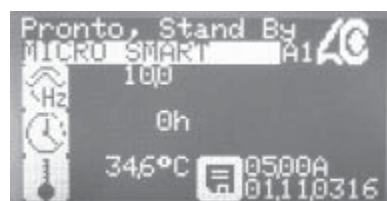

Menú de control "A2"

Son visibles el número de veces que el Micro-Smart ha sido encendido (Power Cycles), las horas de trabajo totales (Uptime), el número de veces de activación del aspirador (Work Cycles), las horas efectivas de uso del aspirador (Work Time), las horas de trabajo y frecuencia (HZ) utilizada y el número de activaciones del ventilador (Fan Cycles).

Flecha derecha 

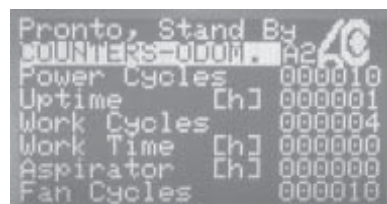

Menú de alarmas "A3"

Son visibles las últimas indicaciones o alarmas ocurridas en el Micro-Smart. Las indicaciones vienen indicadas con un número, para la codificación consultar la tabla de la pag. 119.

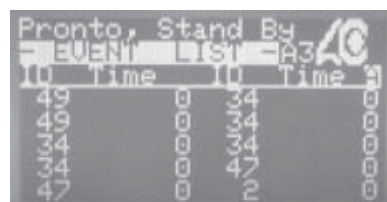



Menú de control "A2"

COUNTERS – ODOM . A2

POWER CYCLES	000000	Número de encendidos del interruptor general
UPTIME [h]	000000	Horas totales de encendido (con los motores apagados)
WORK CYCLES	000000	Número de activaciones del comando de aspiración
WORK TIME [h]	000000	Horas de trabajo efectivo (motores en funcionamiento)
ASPIRATOR [h]	000000	Horas de trabajo y frecuencia (HZ) utilizada
FAN CYCLES	000000	Número de activaciones de la ventola de ventilacion de la central

Menús secundarios

Pulsando  se accede a los menús secundarios.

Desde este menú se accede a los siguientes pulsando la flecha 

Drive Status (Acceso libre)

A este menú se accede sin necesidad de “Password”, se pueden visualizar aquí informaciones útiles sobre el funcionamiento.

User Parameters (Parámetros usuario)

Se accede introduciendo la password “0000123000”.

Permite modificar el nivel de vacío y el idioma.

System Parameters Setup (Ajustes datos del sistema)

Se accede introduciendo la password “0000456000”.

Permite modificar el retardo de parada y otros parámetros de tipo técnico.

Factory Settings Restricted Access (Ajustes fábrica. Acceso restr.)

Menú no accesible al público, es para uso exclusivo de la fábrica Cattani.

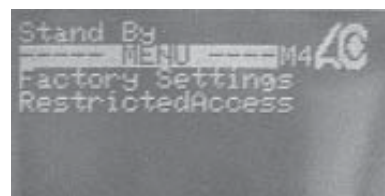
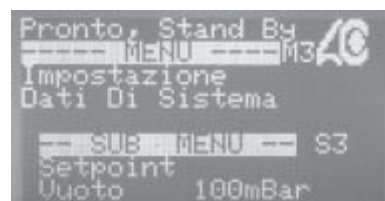
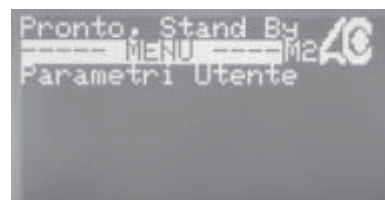
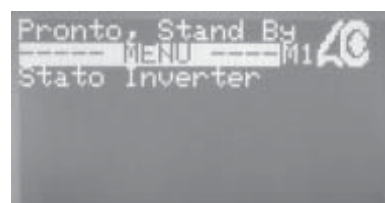
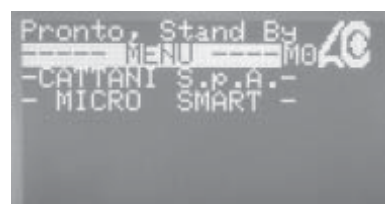
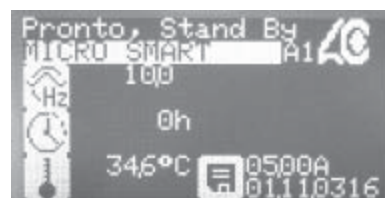

scroll down button
↓



Como entrar e introducir la "Password"

Drive Status es sólo un menú de consulta sin uso de ninguna "Password".

Para entrar en los menús "User Parameters" y "System Parameters Setup" se tiene que introducir obligatoriamente una "Password" :

"Password" de acceso al menú "User Parameters" "0000123000".



"Password" de acceso al menú "System Parameters Setup" "0000456000".



Del menú "CATTANI S.p.A.", pulsar la flecha  después la flecha . En el display aparecerá el menú "Access Password" 0000000000.

Ahora pulsando el botón , aparecerá el cursor sobre el 0 a la derecha.

Pulsando  llevar el cursor sobre el sexto 0.

Pulsando  aparecerá 1.

Pulsar  ir al 0 de al lado y con  escribir 2.

Pulsar  ir al 0 de al lado y con  escribir 3.

Pulsar el botón Enter  para confirmar la "Password" y el cursor desaparecerá.

Pulsar  para volver al menú "Cattani S.p.A."

Ahora será posible modificar los parámetros del menú "User Parameters".

Repetir el mismo procedimiento introduciendo la password 0000456000 para acceder a las modificaciones del menú "System Parameters Setup".

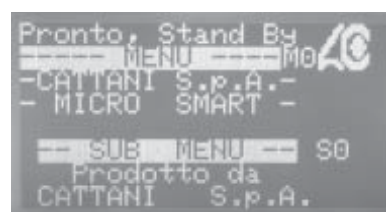
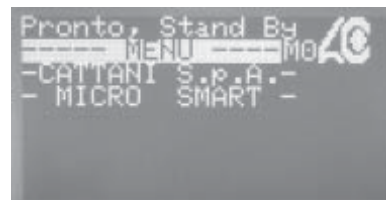

Drive Status Menu (Menú Acceso Libre)

Este menú es visible sin la introducción de ninguna "password", y tiene como finalidad hacer visibles algunos parámetros del estado de funcionamiento del Micro-Smart. A continuación se indican algunos de éstos parámetros.

Blower Output Frequency (Frecuencia Actual Motor Aspiración) (Máx. 120 Hz)

Blower Output Voltage (Tensión Salida Motor Aspiración) (Máx. 220 V)

Blower Overall Current (Corriente Motor Aspiración) (Máx. 4,3 A)

Pump (Centrifuge) Output Frequency (Frecuencia Salida Separador Centrífugo) (75 Hz no variables)

Pump (Centrifuge) Output Voltage (Tensión Salida Separador Centrífugo) (Máx. 220V)

Pump (Centrifuge) Overall Bus Current (Corriente Separador Centrífugo) (Máx. 3,2 A)

scroll down button

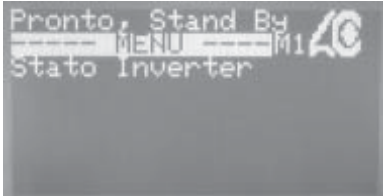

```
Pronto, Stand By
----- MENU ----- M1
Stato Inverter
```

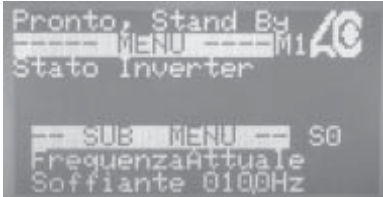

```
Pronto, Stand By
----- MENU ----- M1
Stato Inverter

-- SUB MENU -- S0
Frequenza Attuale
Soffiante 0100Hz
```

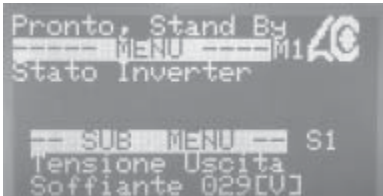

```
Pronto, Stand By
----- MENU ----- M1
Stato Inverter

-- SUB MENU -- S1
Tensione Uscita
Soffiante 029[V]
```

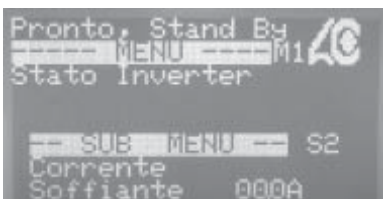

```
Pronto, Stand By
----- MENU ----- M1
Stato Inverter

-- SUB MENU -- S2
Corrente
Soffiante 000A
```



```
Pronto, Stand By
----- MENU ----- M1
Stato Inverter

-- SUB MENU -- S3
Frequenza Uscita
Centrifuga 100Hz
```

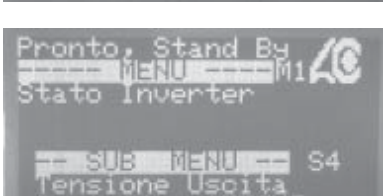

```
Pronto, Stand By
----- MENU ----- M1
Stato Inverter

-- SUB MENU -- S4
Tensione Uscita
Centrifuga 037[V]
```

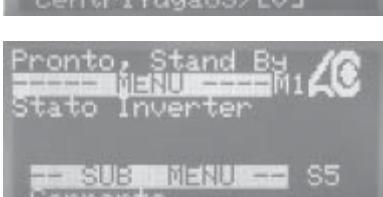

```
Pronto, Stand By
----- MENU ----- M1
Stato Inverter

-- SUB MENU -- S5
Corrente
Centrifuga 000A
```

System Temperature (Temperatura del Sistema)

Maximum Detected Temperature (Máxima Temperatura Detectada) (+60 °C: Alarma y Bloqueo motor Aspiración reseteable)

Maximum Detected Temperature (Máxima Temperatura Detectada) (+60 °C: memoria temperatura no reseteable)

Power Bus Voltage (Tension Bus potencia) (Máx. 390 V)

Max. detected Power Bus Voltage (Máx. Tension Bus potencia detectada) (Máx. 390 V)

Power Bus Ripple (Potencia Bus Ondulada)

Vacuum Set Point (Nivel de Vacío Instantáneo) (Máx. 210 mbar)

```
Pronto, Stand By
----- MENU ----- M1 AC
Stato Inverter

--- SUB MENU --- S6
Temperatura
Dissipatore 34,8°C
```

```
Pronto, Stand By
----- MENU ----- M1 AC
Stato Inverter

--- SUB MENU --- S7
Massima Temperatur
Memorizzata 36,2°C
```

```
Pronto, Stand By
----- MENU ----- M1 AC
Stato Inverter

--- SUB MENU --- S8
Massima Temperatur
Assoluta 36,2°C
```

```
Pronto, Stand By
----- MENU ----- M1 AC
Stato Inverter

--- SUB MENU --- S9
Tensione Bus
Potenza 309 U
```

```
Pronto, Stand By
----- MENU ----- M1 AC
Stato Inverter

--- SUB MENU --- S10
Massima Tensione
BUS Memoriz. 323U
```

```
Pronto, Stand By
----- MENU ----- M1 AC
Stato Inverter

--- SUB MENU --- S11
Ripple Bus
Potenza 000 U
```

```
Pronto, Stand By
----- MENU ----- M1 AC
Stato Inverter

--- SUB MENU --- S12
Livello Quoto
-01 mBar
```

scroll down button





Run mode (Modo funcionamiento: describe como debe trabajar la máquina)

User Parameters Menu (Menú Parámetros usuario)

A este menú se accede introduciendo la "Password de Acceso" 0000123000 (ver instrucciones en la pag. 107).

Vacuum Set Point (Set Point Vacío)

Muestra el nivel de vacío seleccionado.

Pulsar  Enter para modificar, con las flechas   introducir el valor deseado. Pulsar  Enter para confirmar la modificación.

Language (Idioma)

Es posible la selección entre idioma Inglés (1), Italiano (0), Francés (2) o Alemán (3).

Pulsar  Enter y con las flechas   seleccionar 0 o 1 o 2 o 3.

Pulsar  Enter para confirmar la modificación.

Generated Code (Código Generado)

Este código es generado por Cattani S.p.A. Cada aparato tiene un código único específico. Por el momento no tiene ningún tipo de uso.

Activation Code (Código de Activación)

Esta ventana de momento no es utilizable.

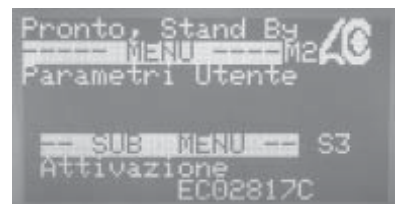
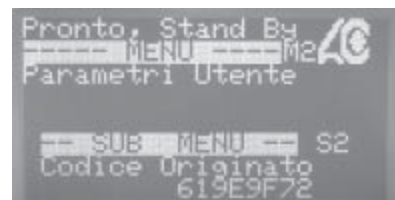
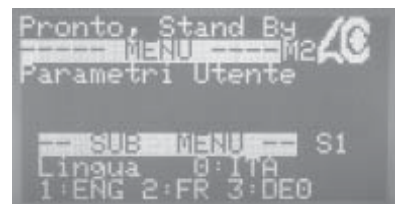
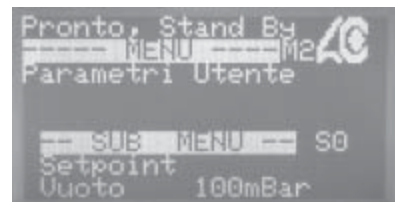
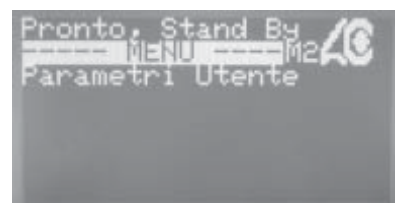
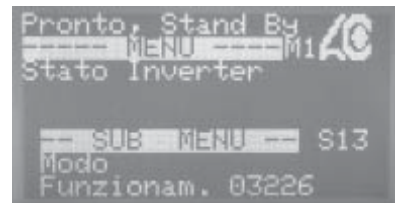







scroll down button

System Parameters Setup Menu (Menú Ajustes Datos del Sistema)

A este menú se accede introduciendo la "Password de Acceso" 0000456000 (ver instrucciones en la pag. 107).

Será ahora posible realizar algunas modificaciones.

Para cambiar los parámetros en este menu: Mover las páginas de los menús con las flechas   para buscar el o los parámetros a modificar.

Pulsar  Enter para activar el cursor, con las flechas   introducir el valor deseado. Pulsar  Enter para confirmar la modificación y continuar.

Todos los parámetros pueden ser regulados.

Min. Vacuum Setting (Nivel de Vacío Mínimo)

Max. Blower Output Frequency at the Min. Setting (Máx. Frecuencia Salida Motor Aspiración al Nivel de Vacío Mínimo)

Blower Overall Current limit at the min. level (Limite Corriente Motor Aspiración al Nivel de Vacío Mínimo)

Medium Vacuum Level (Nivel de Vacío Medio)

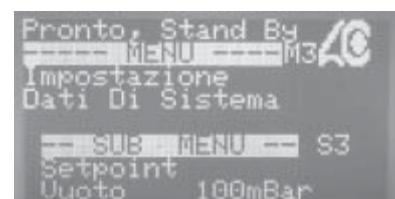
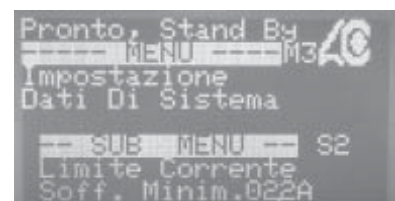
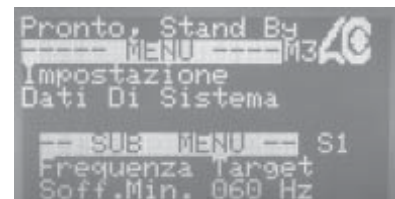
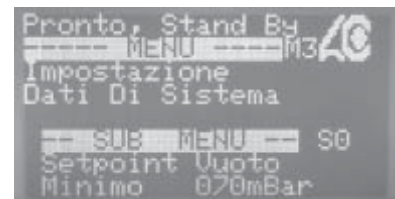

scroll down button

Max. Blower Output Frequency at the Medium Setting (Máx. Frecuencia Salida Motor Aspiración al Nivel de Vacío Medio)

Blower Overall Current limit at the Medium Setting (Limite Corrente Motor Aspiración al Nivel Medio)

Surgery Vacuum Level (Nivello de Vacío Quirúrgico)

Max. Blower Output Frequency at the Surgery Setting (Máx. Frecuencia Salida Motor Aspiración al Nivel de Vacío Quirúrgico)

Blower Overall Current limit at the Surgery Setting (Limite Corrente Motor Aspiración al Nivel de Vacío Quirúrgico)

Off Delay Time (Retardo Apagado) (Máx.: : 300")

Pump Off Delay Time (Retardo Apagado Bomba) (Máx.: 30')

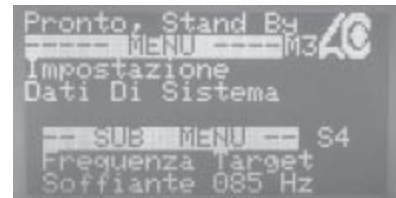

```
Pronto, Stand By
----- MENU ----- M3 AC
Impostazione
Dati Di Sistema

--- SUB MENU --- S4
Frequenza Target
Soffiante 085 Hz
```

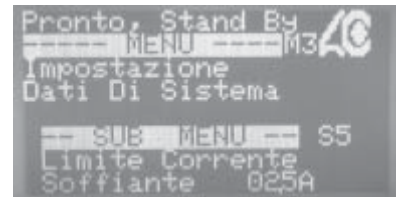

```
Pronto, Stand By
----- MENU ----- M3 AC
Impostazione
Dati Di Sistema

--- SUB MENU --- S5
Limite Corrente
Soffiante 025A
```

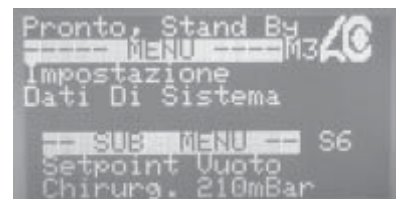

```
Pronto, Stand By
----- MENU ----- M3 AC
Impostazione
Dati Di Sistema

--- SUB MENU --- S6
Setpoint Vuoto
Chirurg. 210mBar
```

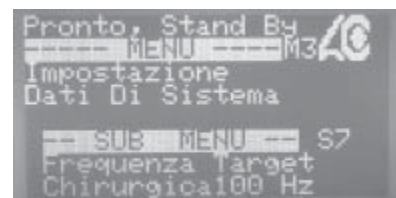

```
Pronto, Stand By
----- MENU ----- M3 AC
Impostazione
Dati Di Sistema

--- SUB MENU --- S7
Frequenza Target
Chirurgica 100 Hz
```

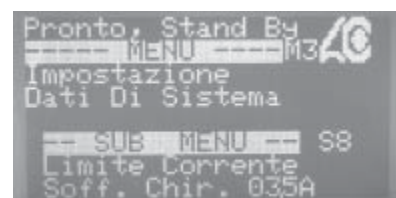

```
Pronto, Stand By
----- MENU ----- M3 AC
Impostazione
Dati Di Sistema

--- SUB MENU --- S8
Limite Corrente
Soff. Chir. 035A
```

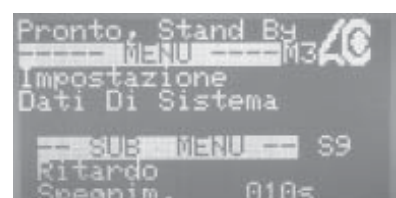

```
Pronto, Stand By
----- MENU ----- M3 AC
Impostazione
Dati Di Sistema

--- SUB MENU --- S9
Ritardo
Spegnim. 010s
```

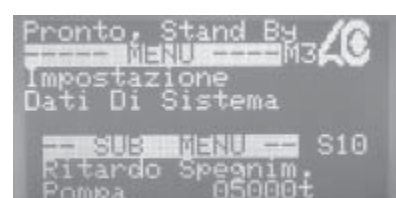

```
Pronto, Stand By
----- MENU ----- M3 AC
Impostazione
Dati Di Sistema

--- SUB MENU --- S10
Ritardo Spegnim.
Pompa 05000t
```

↓ scroll down button

Fan Off Delay Time (Retardo Apagado Véntola) (Máx.: 300")

Running Options (Opciones usadas)

Habilita o deshabilita la lectura del sensor de amalgama.

0-sin separador de amalgama

2-con separador de amalgama

Drive Commands (Comandos Inverter)

Reservado a regulaciones en fábrica.

Modbus address

Este menú no está activado.

Network address

Se especifica la dirección de red del Micro-Smart para la visualización del Zig-Bee.

Zig-Bee Channel Minimum

Se determina sobre qué número de canal mínimo se debe comunicar el Micro-Smart.

Zig-Bee Channel Maximum

Se determina sobre qué número de canal máximo se debe comunicar el Micro-Smart.

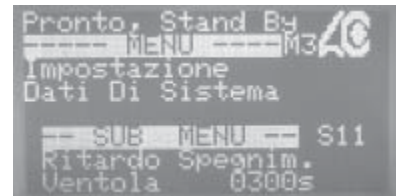

```
Pronto, Stand By
----- MENU -----M3
Impostazione
Dati Di Sistema

-- SUB MENU -- S11
Ritardo Spegnim.
Ventola 0300s
```

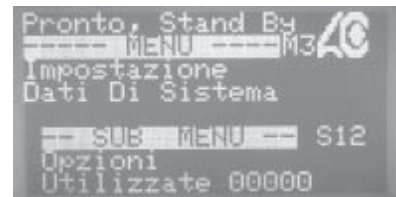

```
Pronto, Stand By
----- MENU -----M3
Impostazione
Dati Di Sistema

-- SUB MENU -- S12
Opzioni
Utilizzate 00000
```

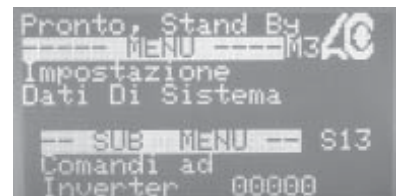

```
Pronto, Stand By
----- MENU -----M3
Impostazione
Dati Di Sistema

-- SUB MENU -- S13
Comandi ad
Inverter 00000
```

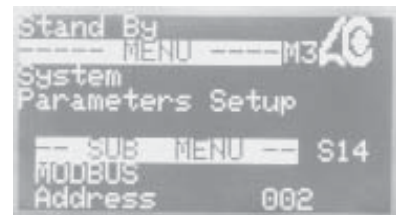

```
Stand By
----- MENU -----M3
System
Parameters Setup

-- SUB MENU -- S14
MODBUS
Address 002
```



```
Stand By
----- MENU -----M3
System
Parameters Setup

-- SUB MENU -- S15
Network
Address 104
```

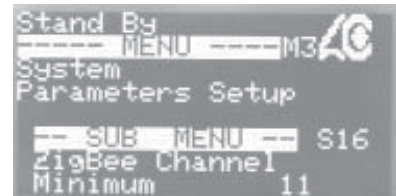

```
Stand By
----- MENU -----M3
System
Parameters Setup

-- SUB MENU -- S16
zigBee Channel
Minimum 11
```

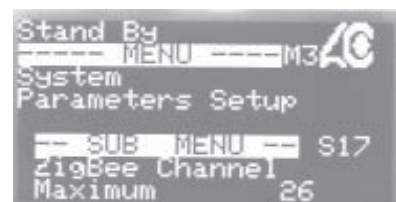

```
Stand By
----- MENU -----M3
System
Parameters Setup

-- SUB MENU -- S17
zigBee Channel
Maximum 26
```

Scroll down button

- *Instrucciones para configurar la comunicación inalámbrica Zig-bee (wireless)*

Ajustar la dirección de red de la máquina.
(mín 100)
(máx 110).

Introducir la llave de comunicación Zig-Bee (ETR-X2USB) en el puerto usb del ordenador y lanzar el programa de visualización.

Instalar el programa "Smart System Monitor" (suministrado por CATTANI S.p.a.) en el ordenador.

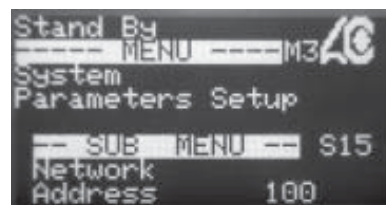

Una vez lanzado el programa aparecerá durante 10 segundos las imágenes de la empresa y después entrará en el menú principal.



Hacer click en el menú SERVICE para poder entrar en la página de la búsqueda de dispositivos.



Hacer click sobre la búsqueda de dispositivos disponibles, el programa iniciará la búsqueda y la operación puede demorarse algunos segundos. Al terminar se podrán visualizar las máquinas disponibles y su correspondiente código generado; podría ser necesario repetir la operación más veces.

Después de que el programa haya encontrado los dispositivos disponibles, se deberá volver a la página principal para poder visualizar los parámetros.

A través del menú de cortina se debe elegir qué Micro-Smart se quiere visualizar.

En ese momento será posible visualizar los parámetros funcionales.

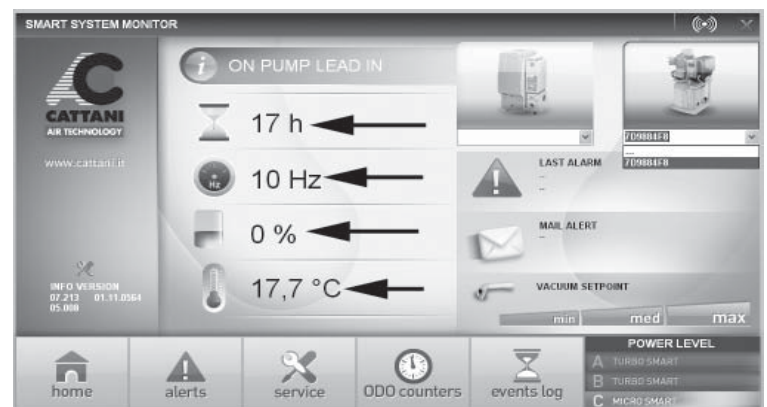
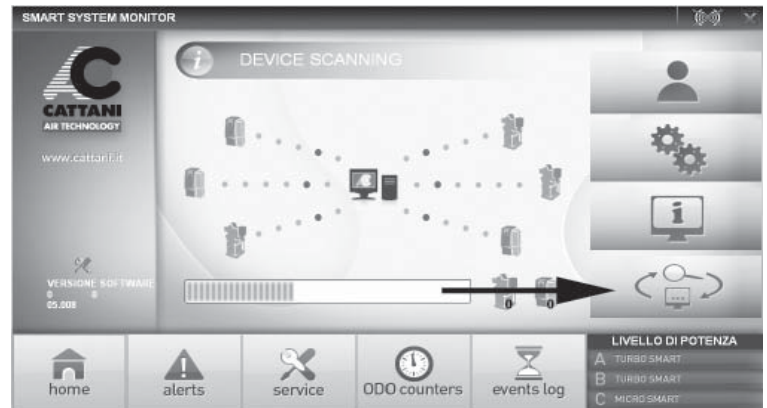

Haciendo click en el icono SERVICE se podrá acceder a tres menús diferentes, uno libre y 2 protegidos por password.

Para entrar en el menú PARAMETROS USUARIO se debe digitar la password 123000 y pulsar "Ok".

En éste menú es posible cambiar el idioma y fijar el nivel de presión deseado.

Para entrar en el menú AJUSTE DATOS DEL SISTEMA se debe digitar la password 456000 y pulsar "Ok".



En éste menú técnico son visibles y modificables todos los parámetros.

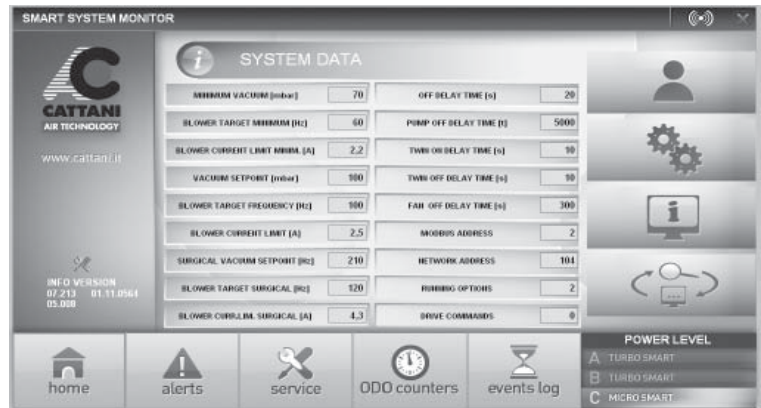

El menú ESTADO INVERTER no necesita ninguna password de acceso y permite visualizar los parámetros funcionales de la máquina mientras está funcionando.



Del menú principal haciendo click en el icono de correo electrónico se podrán introducir los datos, como la dirección del médico y del técnico que deberá recibir las comunicaciones de alarmas.



En caso de anomalía se visualiza una alarma en el display y se envía un e-mail al técnico correspondiente.



Las eventuales alarmas que ocurran durante la jornada, son visibles con un código de error y su descripción en el interior de la casilla “ALERTS”.

En la carpeta EVENT LOG se podrá visualizar todo el histórico de las alarmas que ha tenido la máquina durante todo el período de funcionamiento.

En el menú ODO COUNTERS se memorizan los ciclos de activación.

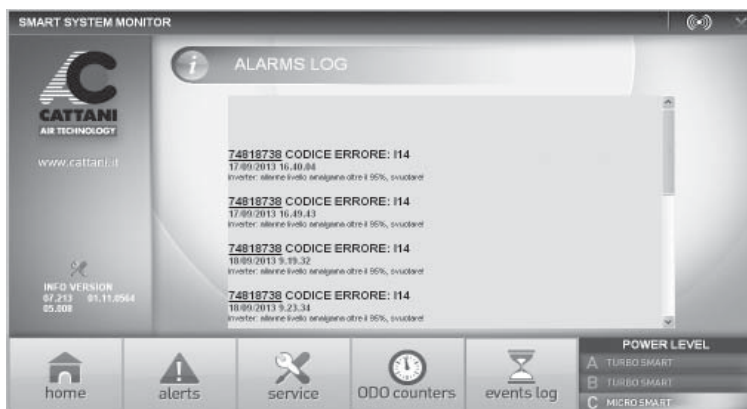
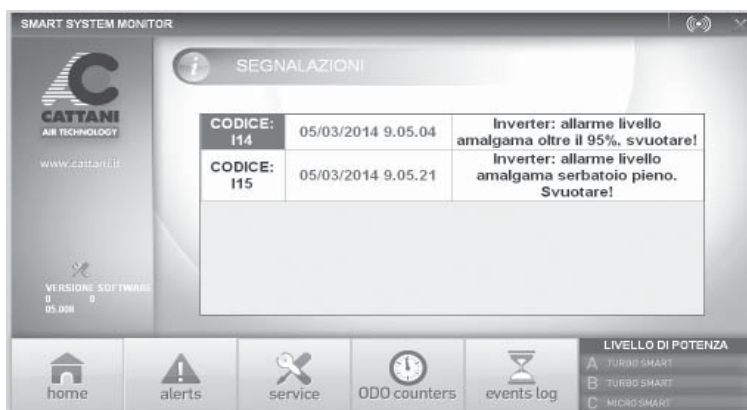

• *Descripciones de alarmas*

Código alarma AC100	DESCRIPCION	REMEDIO
0	Alarma memoria microcontrolador	Contactar con el técnico
32	Alarma memoria microcontrolador	Contactar con el técnico
33	Cortocircuito debido a uno de los dos motores	Verificar de dónde proviene el cortocircuito y eliminarlo
34	Cortocircuito antes del comando de los motores	Contactar con el técnico (probable circuito dañado)
35	Falta carga condensadores	Contactar al técnico (sustituir el circuito)
36	Superado límite de temperatura	Airear la sala de máquinas
37	Superado el límite de corriente del aspirador	Verificar el funcionamiento del aspirador (bloqueo o resistencia excesiva)
39	Superada la tensión máxima en los condensadores	Verificar la tensión de red, máx. 260V
40	Cortocircuito centrífuga	Quitar el cortocircuito
41	Cortocircuito del circuito en la salida de la centrífuga	Sustituir el circuito
42	Superado el límite de corriente instantánea de la centrífuga	Eliminar los sifones de la tubería, o verificar el funcionamiento de la centrífuga (bloqueo o resistencia excesiva)
43	Superado el límite de corriente de retardo de la centrífuga	Eliminar los sifones de la tubería, o verificar el funcionamiento de la centrífuga (bloqueo o resistencia excesiva)
45	Sensor de nivel amalgama desconectado	Conectar el sensor de nivel amalgama
46	Superado el 95% nivel amalgama	Sustituir el contenedor de amalgama en cuanto sea posible
47	Superado el 100% nivel amalgama	Sustituir los contenedores de amalgama
48	Tubo sensor de vacío desconectado	Conectar el tubo sensor de vacío con la centrífuga
49	Pastilla térmica interrumpida	Revisar la temperatura en la sala de máquinas

- *Avisos importantes*
- *Transporte y almacenamiento*
- *Transporte de los aparatos usados*

• *Avisos importantes*

- Los aparatos tienen una garantía de un año a partir de la fecha de venta, con la condición de que se envíe a la empresa fabricante el talón de garantía con la indicación de la fecha de venta, el vendedor y el cliente usuario.
- La garantía y la responsabilidad del fabricante caducan cuando los aparatos son tratados con productos no aptos o distintos de los indicados por el fabricante, utilizados de manera incorrecta, o cuando personas no autorizadas por el fabricante os manipulan.
- La empresa fabricante, los concesionarios, los agentes y los técnicos autorizados están a su disposición para darles sugerencias, indicaciones y para suministrarles documentación, piezas de recambio y todo lo que pueda serles útil.
- Por exigencias técnicas, mejoramiento de los productos, problemas normativos y funcionales, dificultades de encontrar algunos productos y semimanufacturados, la empresa fabricante se reserva el derecho de aportar modificaciones a la producción sin previo aviso.
- En la página web: www.cattani.it se puede encontrar los manuales actualizados. Se aconseja su consulta especialmente para las actualizaciones de seguridad.
- Micro-Smart es un aparato EEE, por lo que se somete a la legislación RAEE (Residuos de Aparatos Eléctricos y Electrónicos).

• *Transporte y almacenamiento*

- Durante el transporte y almacenamiento, los equipamientos embalados podrán ser expuestos a temperaturas comprendidas entre - 10 °C y + 60 °C.
- Los bultos no podrán ser expuestos al agua y salpicaduras y no podrán soportar una humedad superior al 70%.
- Los bultos se pueden superponer sólo en tercera fila si son del mismo peso.

• *Transporte de los aparatos usados*

- Antes de embalar, recomendamos deterger y desinfectar el aspirador con Fast & Steril 3 (véanse los capítulos “Señales y avisos” y “Mantenimiento ordinario”).
- Vaciar todas las tuberías y las comunicaciones exterior/interior. Posibles residuos de líquido (incluido de desinfectante) podrían dañar la centralita. Remover el vaso de recogida de amalgama, añadir el desinfectante y cerrar el vaso con la tapa hermética. Con aspirador seco tanto exteriormente como interiormente, cerrar todas las comunicaciones exterior/interior con la tapa adecuada y montar el vaso de recogida de amalgama nuevo. Procurar embalar separadamente el equipo y la centralita, al fin de maximizar la impermeabilización.
- Cerrar el aparato en saco de polietileno y embalar en cartón ondulado a tres capas.

- SCHEMA DI MONTAGGIO *Micro-Smart*
- *Micro-Smart* INSTALLATION LAYOUT

MONTAGGIO AL PIANO

INSTALLATION ON THE SAME FLOOR OF THE DENTAL UNITS

Fig. A
Draw. A

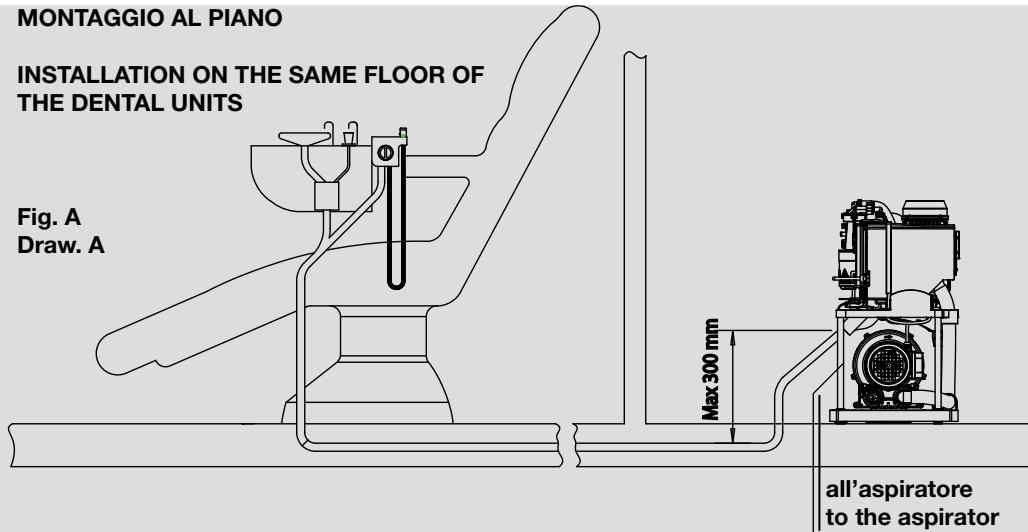

MONTAGGIO SOTTOSTANTE

INSTALLATION ON A LOWER FLOOR THAN THE ONE OF THE DENTAL UNITS

Fig. B
Draw.B

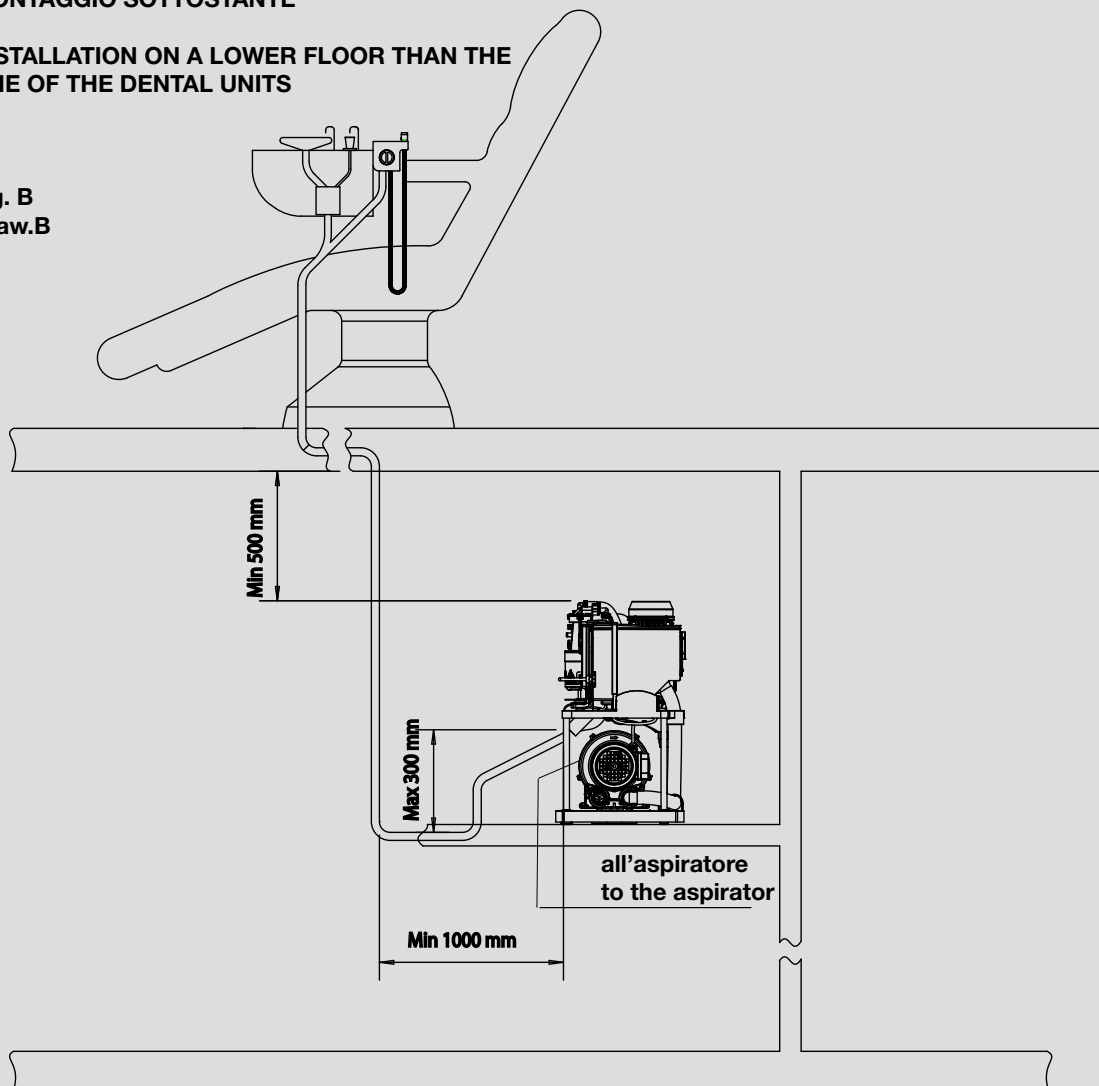

- COLLEGAMENTI CIRCUITO INVERTER AC100
- INVERTER AC100 CONNECTIONS

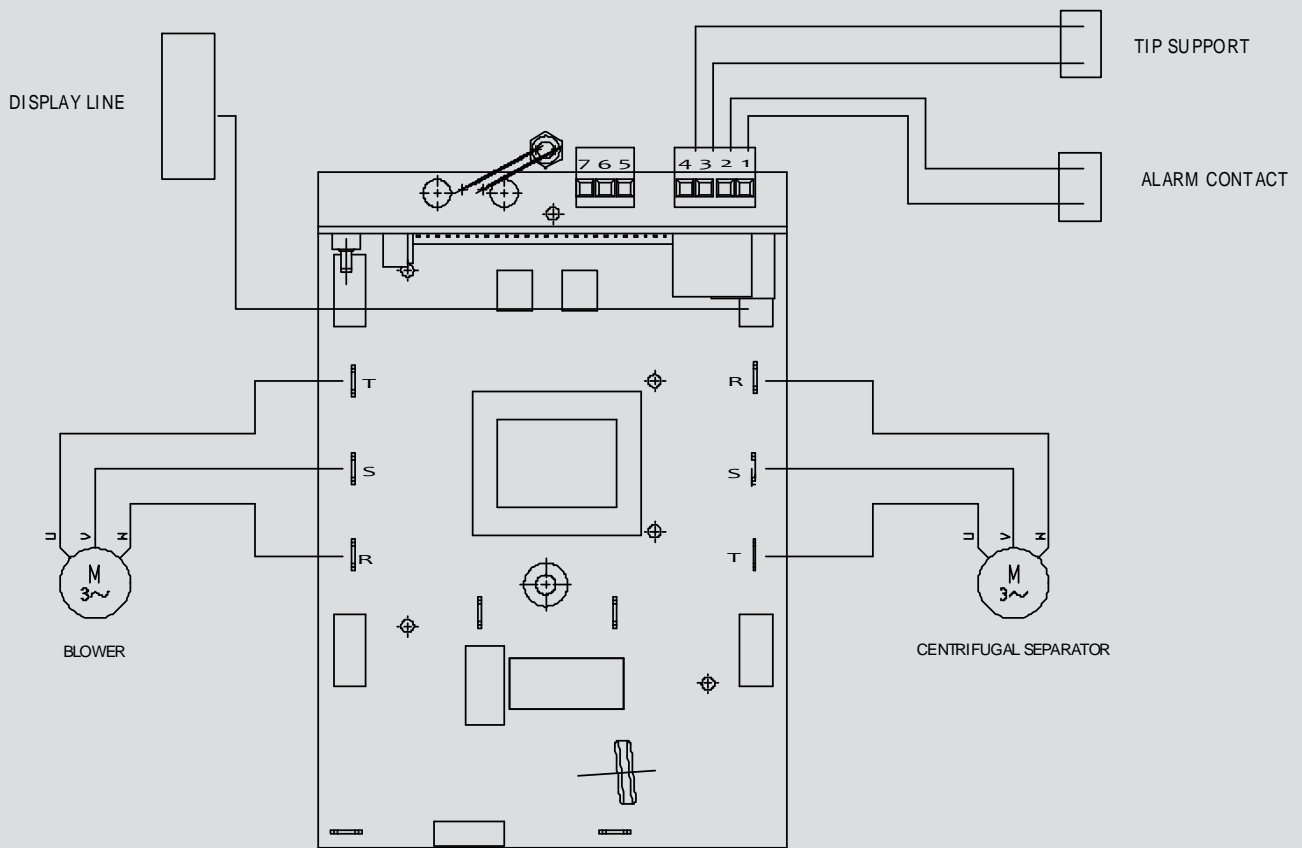

Fig. C

Draw. C

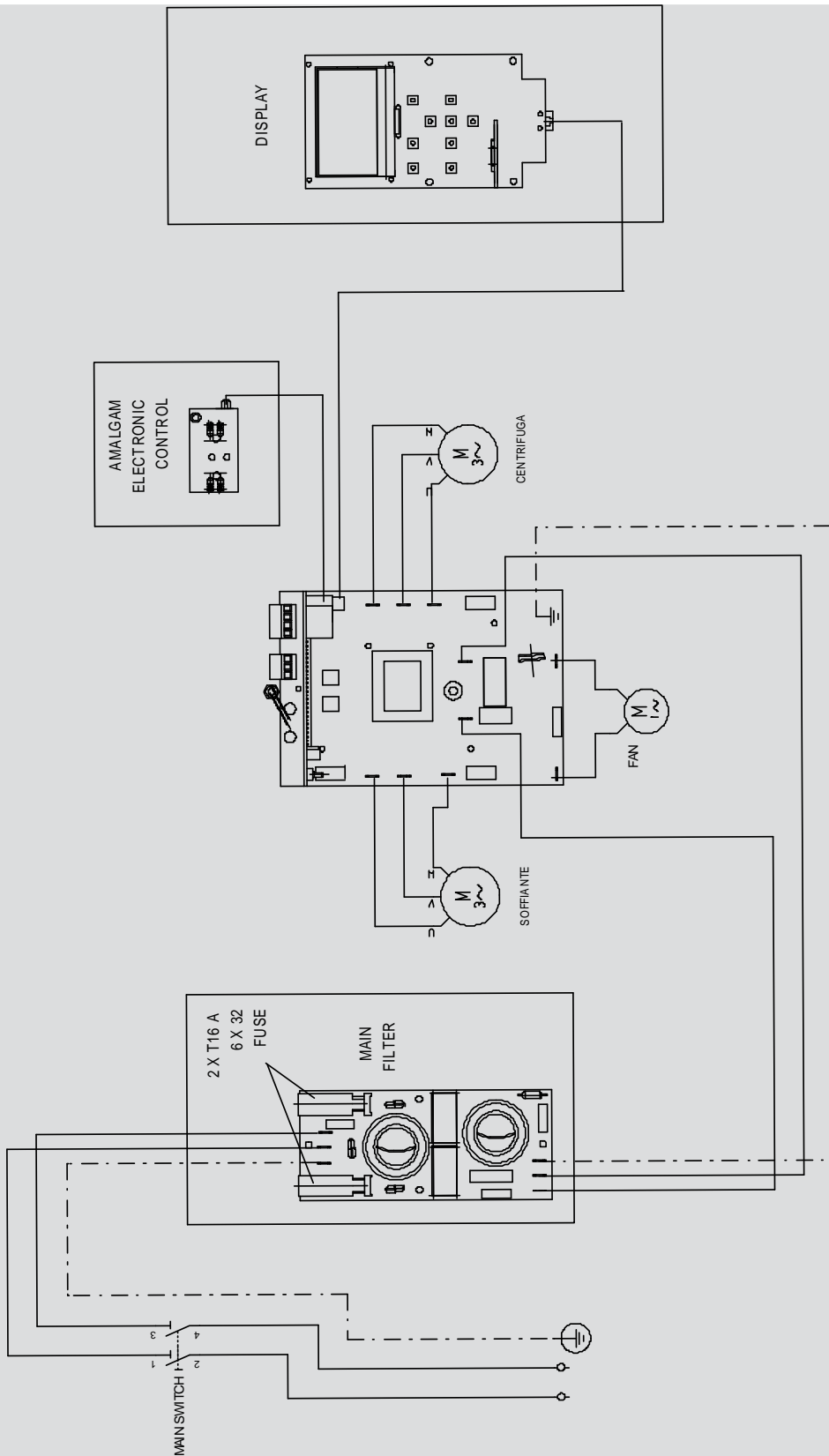

Fig. D

Draw. D

- *PROVE DI DIAGNOSI SU Micro-Smart*
- *DIAGNOSTIC TESTS ON Micro-Smart*

Per verificare il corretto funzionamento di Micro-Smart, si possono effettuare alcuni test di tipo dinamico, di seguito esposti. Si dovrà eseguire il test a macchina in funzione e con l'ingresso d'aspirazione libero, non collegato alla tubazione.

Here below you can find the description of some dynamic tests useful to check the correct working of Micro-Smart. One test must be carried out on running machines with open aspiration inlet not connected to the piping.

	STEP 1 (livello minimo) (minimum setting)	STEP 2 (livello medio) (medium setting)	STEP 3 (livello massimo) (maximum setting)
Set-point livello di vuoto Vacuum set point	70 mbar	100 mbar	210 mbar
Frequenza target Soffiante Max. Blower Output Frequency	60 Hz	85 Hz	120 Hz
Limite "corrente" soffiante Blower Overall Current Limit	2,2 A	2,5 A	4,3 A
Frequenza separatore centrifugo Pump (Centrifuge) Output Frequency	75 Hz	75 Hz	75 Hz
Limite corrente separatore centrifugo Pump (Centrifuge) Overall Bus Current Limit	3,5 A	3,5 A	3,5 A

Fig. E

Draw.E

- *DIAGRAMMA DI LAVORO DI Micro-Smart*
- *Micro Smart WORKING DIAGRAM*

ASPIRAZIONE mbar
ASPIRATION mbar

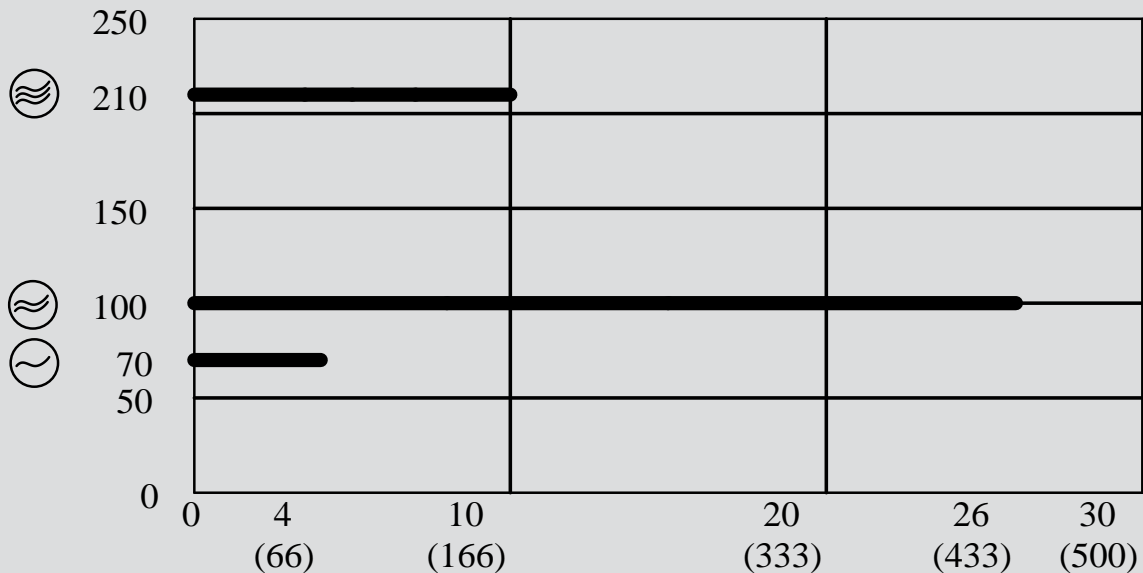

PORTATA m³/h (l/min)
FLOW RATE m³/h (l/min)

 CURVA ASPIRAZIONE MICRO-SMART (SET POINT VUOTO 70 mbar)
 PREVALENZA CONSIGLIATA PER ASPIRASALIVA o ASPIRAZIONE DI FONDO BOCCA.
 ASSORBIMENTO IN (A) Da 0,5 a 1 - INTERVALLO DI FREQUENZA (Hz) Da 50 a 55
 MICRO SMART ASPIRATION CURVE (VACUUM SET-POINT 70 mbar)
 SUGGESTED MAX.HEAD FOR SALIVA EJECTOR OR MOUTH FLOOR ASPIRATION
 ABSORPTION IN (A) from 0.5 to 1 –CYCLE RANGE (Hz) from 50 to 55

 CURVA ASPIRAZIONE MICRO-SMART (SET POINT VUOTO 100 mbar)
 PREVALENZA CONSIGLIATA PER INTERCETTATORE DI SPRUZZI.
 ASSORBIMENTO IN (A) Da 1,1 a 1,9 - INTERVALLO DI FREQUENZA (Hz) Da 60 a 90
 MICRO SMART ASPIRATION CURVE (VACUUM SET-POINT 100 mbar)
 SUGGESTED MAX.HEAD FOR SPRAY INTERCEPTOR
 ABSORPTION IN (A) from 1.1 to 1.9 –CYCLE RANGE (Hz) from 60 to 90

 CURVA ASPIRAZIONE MICRO-SMART (SET POINT VUOTO 210 mbar)
 PREVALENZA CONSIGLIATA PER ASPIRAZIONE CHIRURGICA.
 ASSORBIMENTO IN (A) Da 3,1 a 3,6 - INTERVALLO DI FREQUENZA (Hz) Da 95 a 105
 MICRO SMART ASPIRATION CURVE (VACUUM SET-POINT 210 mbar)
 SUGGESTED MAX.HEAD FOR SURGICAL ASPIRATION
 ABSORPTION IN (A) from 3.1 to 3.6 –CYCLE RANGE (Hz) from 95 to 105

Escludendo i tasti preselezionati, Micro-Smart può lavorare su due poltrone contemporaneamente.

Excluding the preset buttons, Micro-Smart can operate two chairs at the same time.

Fig. F

Draw.F



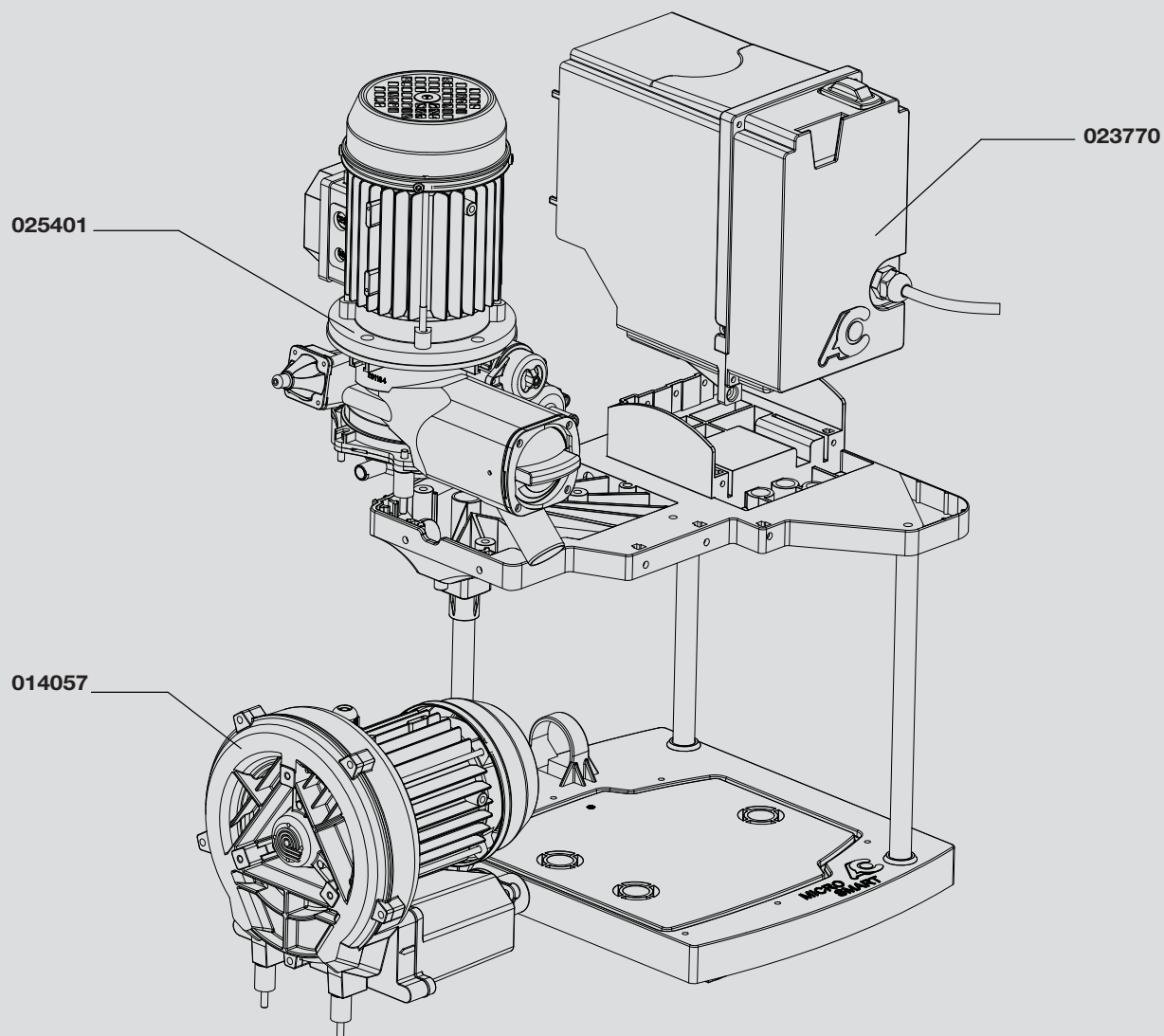

Fig. G

COD. 023770 CENTRALINO ELETTRICO

Draw. G

COD. 025401 SEPARTORE CENTRIFUGO

COD. 014057 SOFFIANTE

CODE 023770 ELECTRIC CONTROL PANEL

CODE 025401 CENTRIFUGAL SEPARATOR

CODE 014057 BLOWER

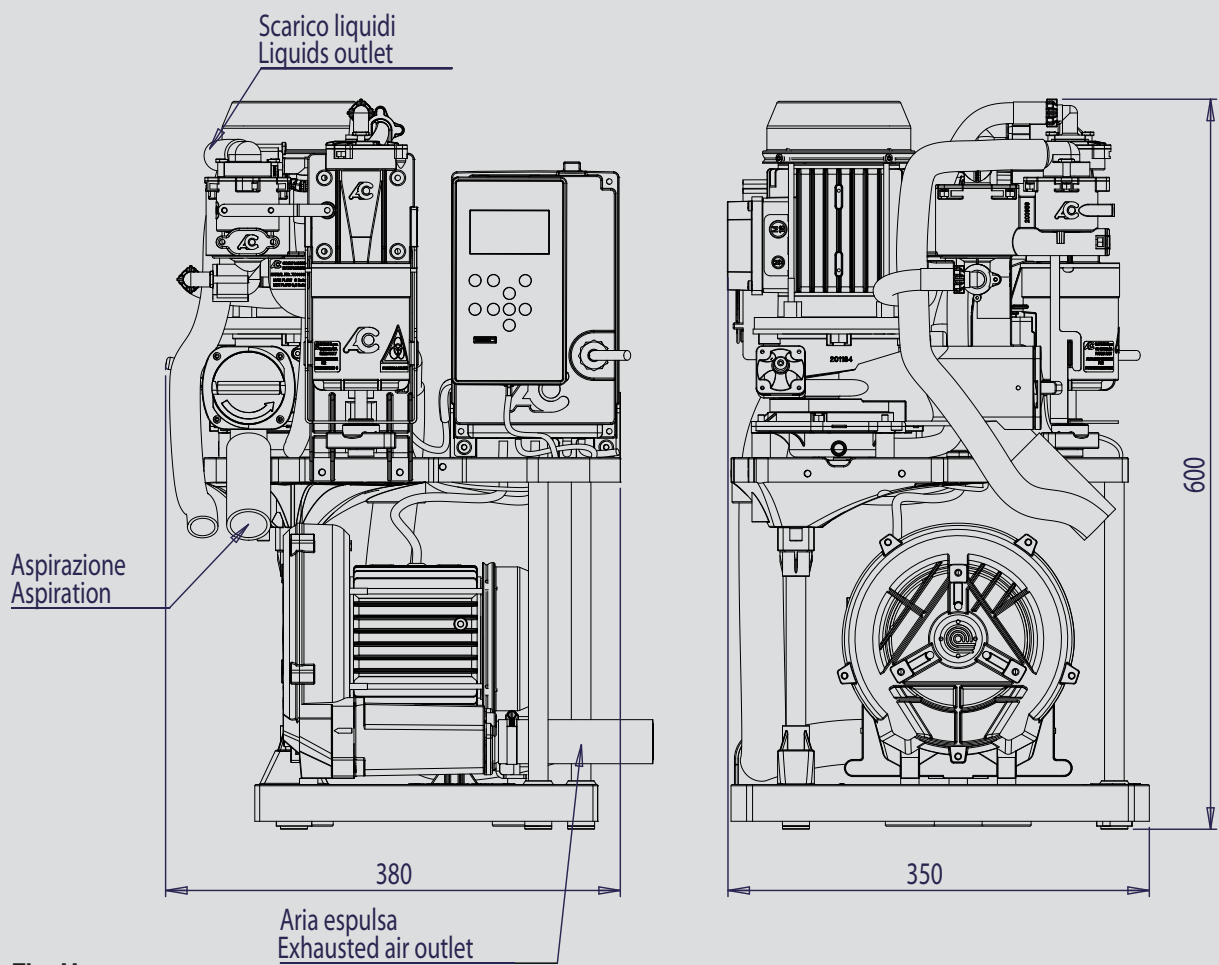

Fig. H

Draw.H

**HOW CAN WE DO
WE LEAD IN OUR FIELD,
YET WE COST LESS THAN
THE ALTERNATIVES?**

THIS IS HOW:

- **WE RESEARCH:** this lets us apply the latest technology in all of our products and solutions.
- **WE INCREASE PERFORMANCE:** electronic and information technology allow us to increase the performance and reliability of our products.
- **WE REDUCE COSTS:** less maintenance and energy costs mean on a cost-benefit analysis we are always the most economical.
- **WE REDUCE ENVIRONMENTAL IMPACT:** we save 50% of primary materials, and allow you to save between 30% and 50% of electrical consumption.

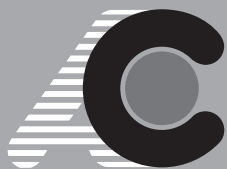

CATTANI

AIR TECHNOLOGY

6/A Via Natta. 43122 Parma, Italy

10°21'48" EST - 44°50'46" NORD

Ph. +39.0521.607604

Fax +39.0521.607628 (Sales Dept.)

Fax +39.0521.607855 (Purchasing Dept.)

Fax +39.0521.399966 (Accounting Dept.)

www.cattani.it - e-mail: info@cattani.it

Company with Quality System Certified according to
UNI EN ISO 9001:2008 - UNI EN ISO 13485:2012

